

**Kit Part Number: 250-1897**

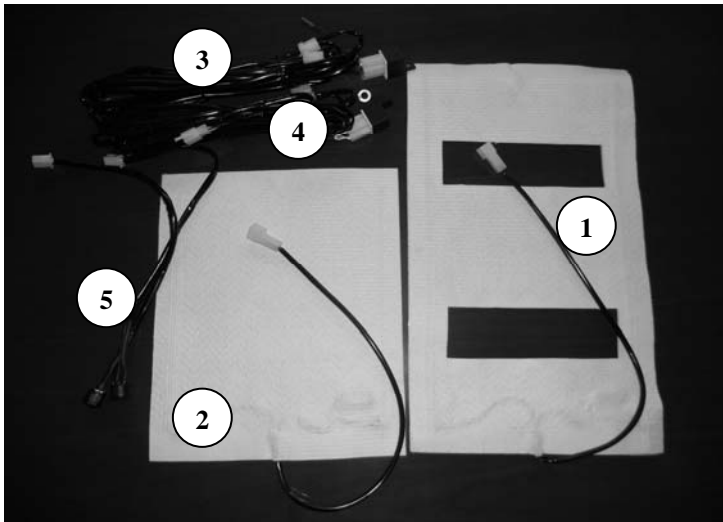

**General Applicability**

Camry LE / SE / XLE
---------------------

**Recommended Sequence of Application**

Item #	Accessory	
1	Wiring	
2	Elements	
3		

**Kit Contents**

Item #	Quantity Req'd.	Description
1	2	Cushion Element
2	2	Back Element
3	1	Driver Main Harness (red)
4	1	Passenger Main Harness (blue)
5	2	Control Switch
6	1	Hardware Bag

**Hardware Bag Contents**

Item #	Quantity Req'd.	Description
1	12	Wire Ties
2		
3		
4		
5		

**Additional Items Required For Installation**

Item #	Quantity Req'd.	Description
	1	Switch Cutout Template
	As needed	Vehicle Protection Blankets

**Conflicts**

Note: Factory leather and cloth

**Recommended Tools**

Item #	Quantity Req'd.	Description

**Legend**

	<b>STOP:</b> Damage to the vehicle may occur. Do not proceed until process has been complied with.
	<b>OPERATOR SAFETY:</b> Use caution to avoid risk of injury
	<b>CRITICAL PROCESS:</b> Proceed with caution to ensure a quality installation.
	<b>GENERAL PROCESS:</b> This highlights specific processes to ensure a quality installation.
	<b>TOOLS &amp; EQUIPMENT:</b> This calls out the specific tools and equipment required for this process
	<b>VEHICLE PROTECTION:</b> This calls out for protection of vehicle required for this process

### Pre-Installation Suggestions



1. Disconnect the negative battery cable and wait for 3 minutes before beginning installation, to avoid unintended air bag deployment. Note and record any anti-theft radio codes prior to disconnecting. **Figure 1**
2. If vehicle is in Electronics work area, proceed to step 1 page 4. If vehicle is in Leather shop, proceed to next section “Install Heating Elements”.

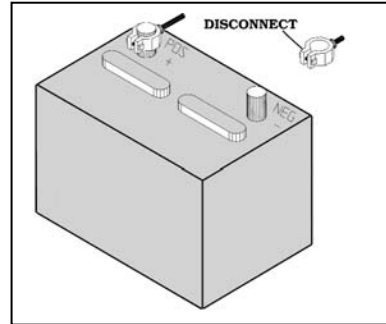

Figure 1

### Install Heating Elements



1. Remove seats from vehicle per vehicle’s service manual and place on a clean work surface.
2. Remove seat covers per vehicle’s service manual.



3. **Caution: The heating elements must be installed wrinkle-free.**



4. Obtain the back heating element. Remove the protective layer from the element’s double sided tape and place it onto the seat back foam roughly centered on the foam from side to side with the top of the element just below the transverse listing (tie bar trench). **Figure 2**



Figure 2



5. Route the element wiring harness down to the bottom of the seat back, inboard of the hinge cover and under the seat.

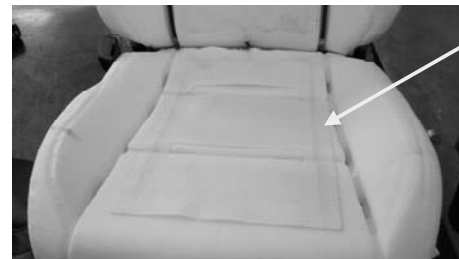

Align channels with cutouts

Figure 3



6. Repeat the process above for the seat cushion, laying the heating element transversely such that it does not interfere with the horizontal listings. **Figure 3**



Route harnesses here

Figure 4



7. Secure the seat harnesses to the tie down bar and run down the side listing to the back of the seat, then down. Re-attach seat covers. **Figures 4-5**

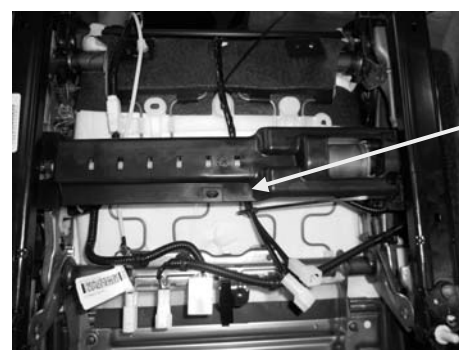

Twist harnesses together and route here

Figure 5



8. Replace the driver and passenger seats into the vehicle. Connect the seat element connectors to the main harnesses. Secure the harness with wire ties and allow adequate slack to prevent damage during seat adjustment. **Figure 6**

**Install Heating Elements (cont'd)**

- ➔ **9.** Make sure vehicle floor-pan is clear and carefully re-locate seat into vehicle.
- ➔ **10.** Ensure all connectors under seat have been properly connected and secured with wire ties, and that nothing will be damaged upon seat movement.
- ⚠ **11.** Install seat bolts and torque per service manual.
- ⊕ **12.** Reconnect battery cable(s). Torque 10mm bolt to 48 inch-pounds. Re-enter any theft deterrent information, if applicable.
- ⚠ **13.** Note: If the passenger seat cushion has a Seat Occupant Sensor for Airbag Deployment, it must be re-calibrated per guidelines in the Factory Repair Manual.
- 14.** Place the Seat Heater Operation Instructions in the glove box.

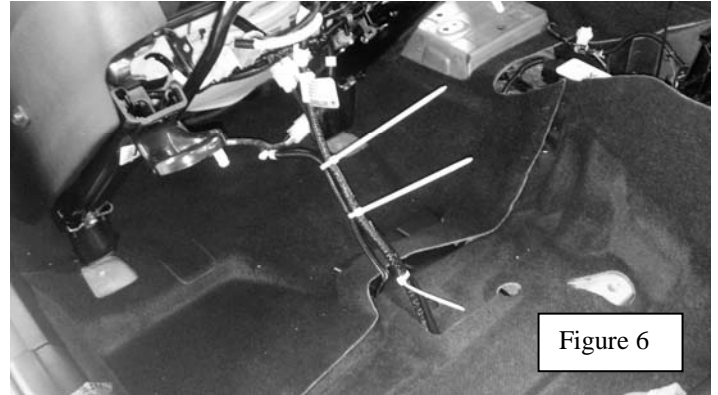
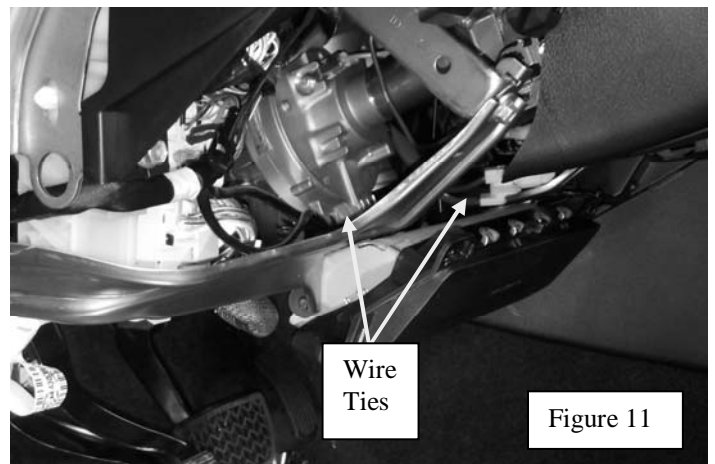
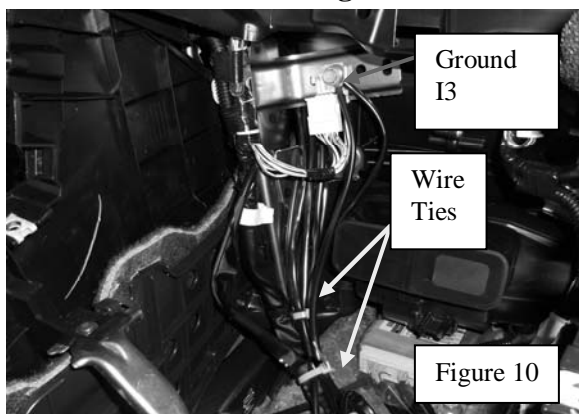
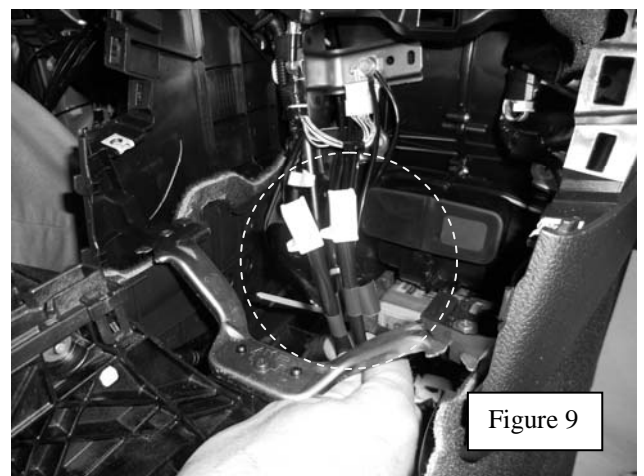
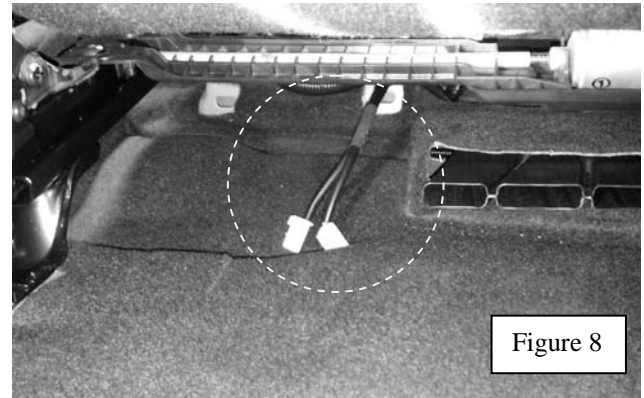
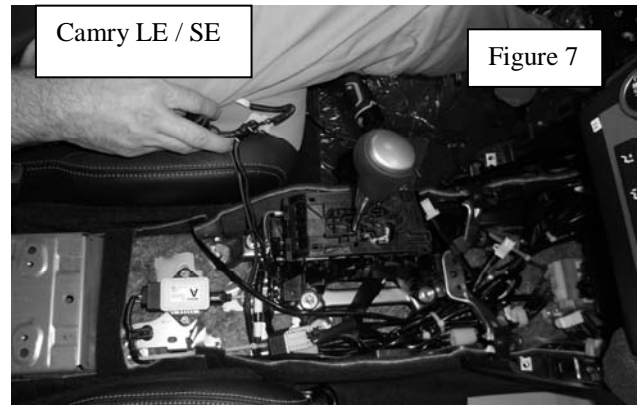

Figure 6

Section II –Installation

Install Main Harnesses

- ⚠ 1. Remove the shift knob bezel / cup holders, and center floor console.
  - ➡ 2. Install the driver (red tape) and passenger (blue tape) main power harnesses near the factory floor harness as shown. **Figure 7**
- NOTE: For XLE models, take care to route the relays and main harnesses beneath the HVAC ducting at the right of the shifter**
- ➡ 3. Route the outputs for the driver (red) and passenger (blue) side seat elements to the opening in the carpet underneath the seat near the air vent. **Figure 8**
  - ➡ 4. Route the inputs for the driver (red) and passenger (blue) side switches to the area in front of the shift knob and set aside. **Figure 9**
  - ➡ 5. Route and connect the two ground terminal rings to ground point **I3** below the HVAC controls. **Figure 10**
  - ➡ 6. Remove left door step, kick panel, and lower instrument panel.
  - ➡ 7. Route the inputs for the driver and passenger power (red and blue wires) to the center console beneath the radio, and left behind the driver knee panel to the driver side junction box. **Figure 11**
  - ⚠ 8. Disconnect connector **3C** from the junction box, and release the locking tabs on the connector. Insert the red wire (driver side power) into **Pin 4** of connector **3C**. Insert the blue wire (passenger side power) into **Pin 13** of connector **3C**. Replace the locking tabs on the connector and reconnect the connector to the Junction Box. **Figure 12a**



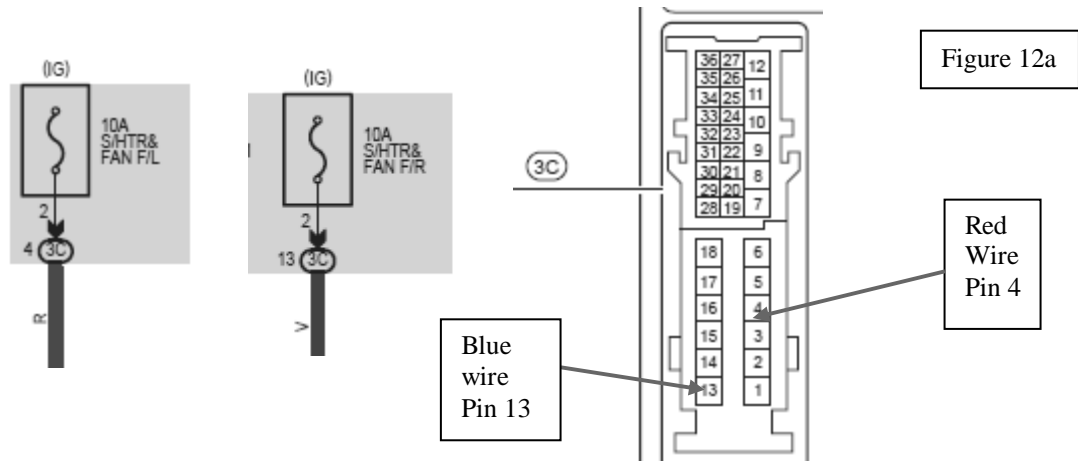

9. **NOTE:** XLE models with SmartKey may be pre-wired for the factory seat heater (**Figure 12b**). In this case remove the **RED** and **VIOLET** wires from **Pin 4** and **Pin 13** respectively, and tape them to the harness as shown in **Figure 12c**.

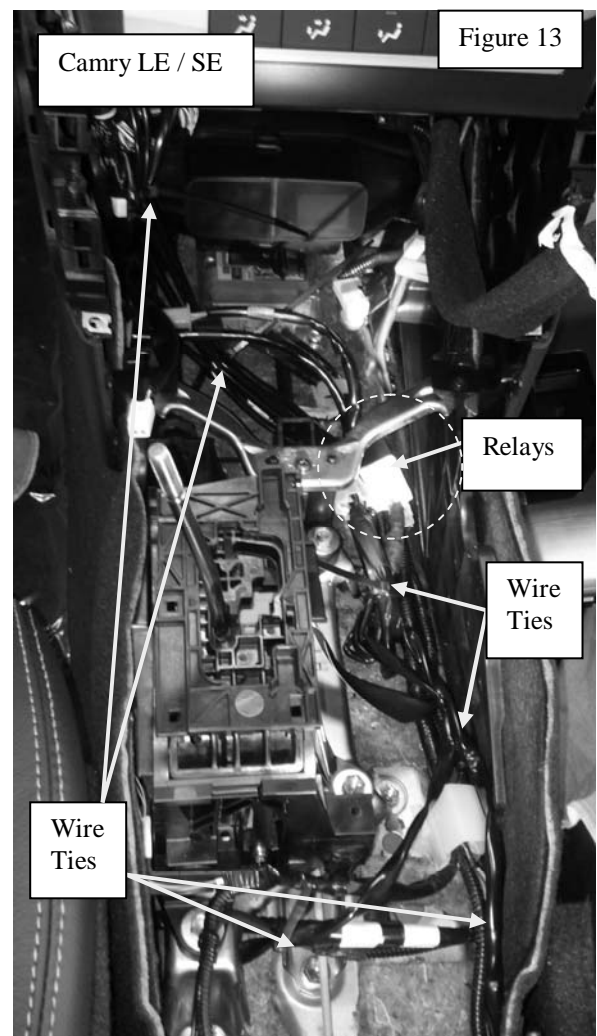
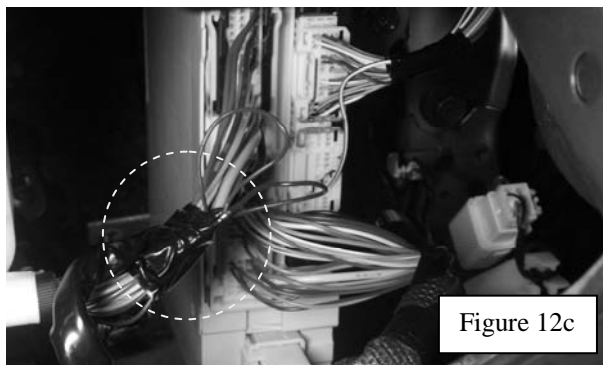
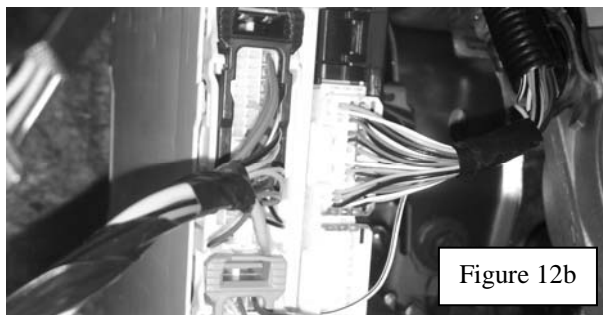

10. Secure the harnesses with wire ties to the factory harness in center console and behind the driver knee panel. **Figures 11, 13 (Camry LE / SE shown)**

Install Switches



1. Use the Camry drill fixture to make 3/8” pilot holes in trim piece. Enlarge hole with a 13/16” (21mm) hole saw. **Figures 14a-15**

NOTE: Camry LE / SE share one fixture, Camry XLE is a separate fixture.



2. Push the switch harness through hole and snap the switch firmly into place. **Figure 16**



3. Connect the switches to the switch inputs on the main harnesses in the center console. Connect left (driver) switch to the 4-pin connector marked with the red tape, and connect the right (passenger) switch to the 4-pin connector marked with the blue tape.
4. Use the Seat Heater Harness Tester to validate switch and harness function and orientation.
5. Reinstall all trim panels in the reverse order of removal.
6. Reconnect battery cable(s). Torque 10mm bolt to 48 inch-pounds. Re-enter any theft deterrent information, if applicable.

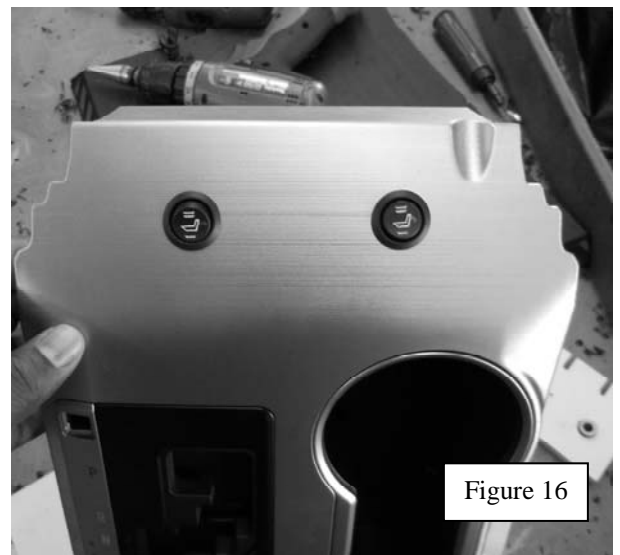
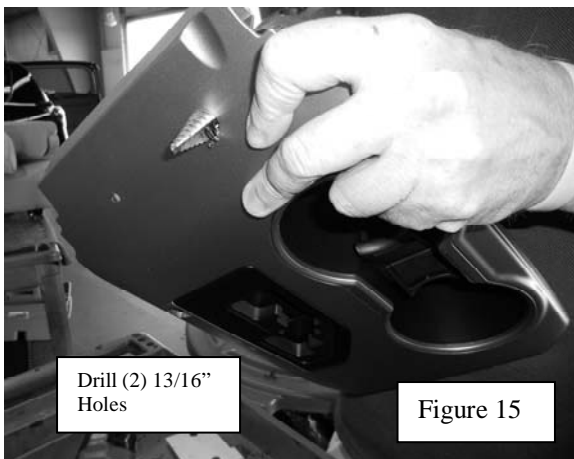
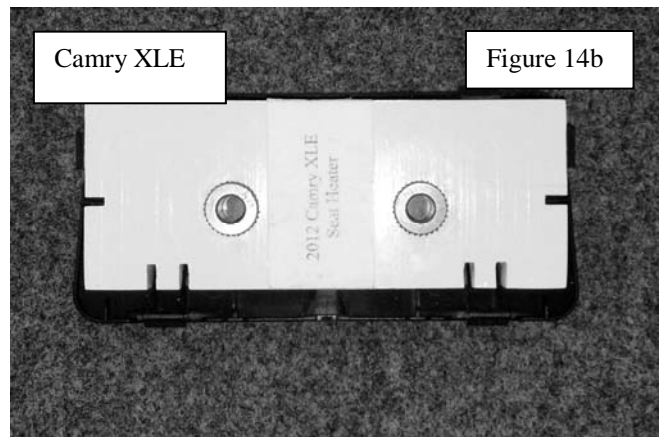
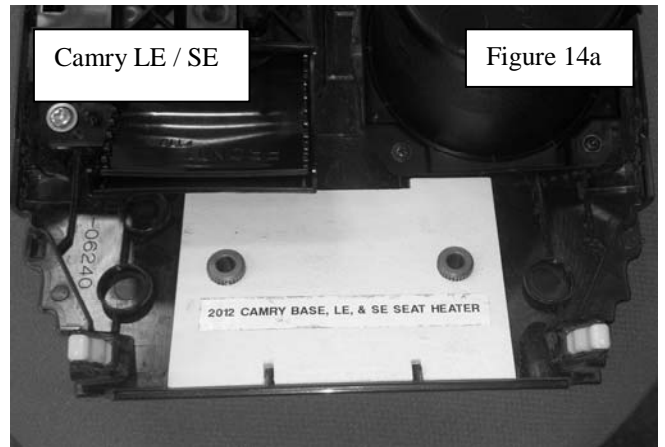

<b>Check</b>	<b>Look For</b>
Verify Function and Heat: IGN ON, Check switch in both ‘High’ and ‘Low’ position.	Switch in ‘High’ setting. The LED will turn <u>red</u> . The heat will be noticeable within 3 minutes. The heating time can vary according to the type of seat cover material and kind of clothing/coat that is being worn. The heating must be switch to the ‘Low’ setting in order to avoid overheating, when the desired temperature has been reached.
	Switch in ‘Low’ setting. The LED will turn <u>green</u> . The heating time can vary according to the type of seat cover material and kind of clothing/coat that is being worn.

**Troubleshooting**

The heating does not function although it is switched on. The LED is not illuminated.	Check the fuse and change if necessary.
The LED in not illuminated although the heating is functioning and switched on.	The LED in the switch is defective.
The heating does not function although it is switched on. The LED is on.	The temperature of the seat cover could be too high due to high interior temperature. The thermostat in the seat heating unit is connected. Wait until the seat cover’s temperature has fallen and try again.
The fuse burns out repeatedly.	Verify the fuse rating is correct: 10 amps.

**Notes:**