

**GENERAL APPLICABILITY**

THIS CRUISE WAS TESTED AND VERIFIED ON:  
 FORD TRANSIT 150, 250

**KIT CONTENTS/SERVICE PARTS**

ITEM	QTY	DESCRIPTION	PART#
1	1	CRUISE CONTROL MODULE	250-2879
2	1	SWITCH HARNESS	250-2760
3	1	PEDAL INTERFACE HARNESS	250-2804
4	1	CONTROL SWITCH	250-2867
5	1	DIAGNOSTICS HARNESS	250-2783



**HARDWARE BAG CONTENTS**

ITEM	QTY	DESCRIPTION
1	8	WIRE ZIP TIES
2		
3		







**RECOMMENDED TOOLS**

<b>PERSONAL &amp; VEHICLE PROTECTION</b>	
SAFETY GLASSES	
<b>SPECIAL TOOLS</b>	
VOLT-OHM METER	
<b>INSTALLATION TOOLS</b>	
TRIM REMOVAL TOOL	PHILLIPS SCREWDRIVER
10MM WRENCH	
DRILL BITS	9.5MM OR 3/8" (FOR SWITCH)
14MM WRENCH	
SOLDERING TOOL	
<b>SPECIAL CHEMICALS</b>	

**CONFLICTS**

**NOTE:**

**LEGEND**

-  **STOP:** DAMAGE TO VEHICLE MAY OCCUR. DO NOT PROCEED UNTIL PROCESS COMPLIANCE HAS BEEN MET.
-  **OPERATOR SAFETY:** USE CAUTION TO AVOID RISK OF INJURY.
-  **CRITICAL PROCESS:** PROCEED WITH CAUTION TO ENSURE A QUALITY INSTALLATION. THESE POINTS WILL BE AUDITED ON A COMPLETED VEHICLE INSTALLATION.
-  **GENERAL PROCESS:** THIS HIGHLIGHTS SPECIFIC PROCESSES TO ENSURE A QUALITY INSTALLATION. THESE POINTS WILL BE AUDITED DURING THE ACCESSORY INSTALLATION.
-  **TOOLS & EQUIPMENT:** THIS CALLS OUT THE SPECIFIC TOOLS AND EQUIPMENT REQUIRED FOR THE PROCESS.
-  **REVISION MARK:** THIS MARK HIGHLIGHTS A CHANGE IN INSTALLATION WITH RESPECT TO PREVIOUS ISSUE.



**WARNING: DO NOT USE HAND-HELD 2-WAY TRANSCEIVERS INSIDE YOUR VEHICLE WHILE DRIVING.**

WHEN TRANSMITTING FROM INSIDE THE CAR, 2-WAY RADIOS THAT OPERATE IN THE 25MHZ-700MHZ FREQUENCY RANGE WITH MORE THAN 2.0 WATTS OF POWER CAN PRODUCE ELECTROMAGNETIC INTERFERENCE THAT COULD INTERFERE WITH THE OPERATION OF CRUISE AND THROTTLE CONTROLS RESULTING IN VEHICLE "LIMP MODE".

USE OF CELLULAR PHONES WILL NOT INTERFERE WITH THESE CONTROLS.



**DUE TO SENSITIVE NATURE OF SIGNALS USED FOR THIS PRODUCT, ALL NON-PLUG AND PLAY CONNECTIONS MUST BE SOLDERED. FAILURE TO COMPLY WITH THIS REQUIREMENT WILL VOID WARRANTY.**



## BEFORE INSTALLATION

TO MAKE THE INSTALLATION EASIER THE COMPLETE INSTALLATION INSTRUCTIONS SHOULD BE READ THROUGH BEFORE INSTALLATION IS STARTED.

THIS INSTALLATION IS NOT A Do-It-Yourself JOB. THE INSTRUCTIONS CONTAIN IMPORTANT INFORMATION ON HOW TO INSTALL THE ELECTRONIC CRUISE CONTROL.

MODERN CARS ARE EQUIPPED WITH ELECTRONICS WHICH CAN BE DAMAGED BY INAPPROPRIATE TREATMENT.

ROSTRA PRECISION CONTROLS IS NOT RESPONSIBLE FOR ANY ERROR CAUSED BY IMPROPER INSTALLATION.



## STOP - READ BEFORE INSTALLATION IMPORTANT ADVISORY NOTES THAT YOU MUST FOLLOW

ALWAYS DISCONNECT THE NEGATIVE CABLE FROM BATTERY BEFORE INSTALLATION.

ALWAYS USE THE ENCLOSED INSTALLATION INSTRUCTION FOR INSTALLING THE ELECTRONIC CRUISE CONTROL.

ENSURE THE PART NUMBER OF THE CRUISE MODULE LABEL MATCHES THE PART NUMBER OF THE INSTALLATION INSTRUCTIONS.

SAVE ANY RADIO SECURITY CODES THAT MAY BE NEEDED AFTER POWER IS RESTORED TO THE RADIO .

FIND A LOCATION TO INSTALL THE CRUISE MODULE AND CONTROL SWITCH.

ALL WIRE LEADS MUST BE SOLDERED.

IF ANY WIRES ARE UNUSED, TRIM EXCESS WIRE AND INSULATE TO PREVENT SHORTS.

ONLY USE A MULTIMETER TO MEASURE VOLTAGE.

ALWAYS PERFORM A COMPLETE TEST DRIVE BEFORE FULLY REASSEMBLING THE CAR.

INSTALLATION

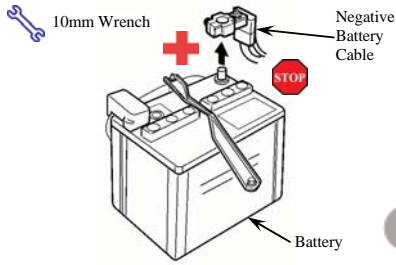

UNPLUG ACCELERATOR PEDAL CONNECTOR AND RUN BYPASS HARNESS IN SERIES AS SHOWN IN PICTURE BELOW.

Connect to the accelerator pedal

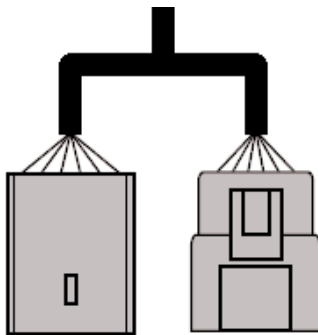

INSTALLATION

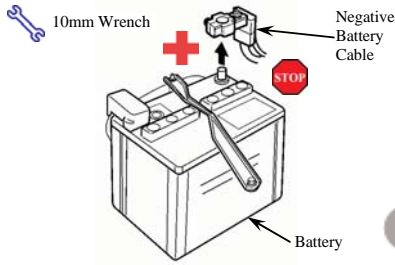

Cut the Rostra connector off and solder wires: Red wire to Pin 6, Black wire to Pin 14.

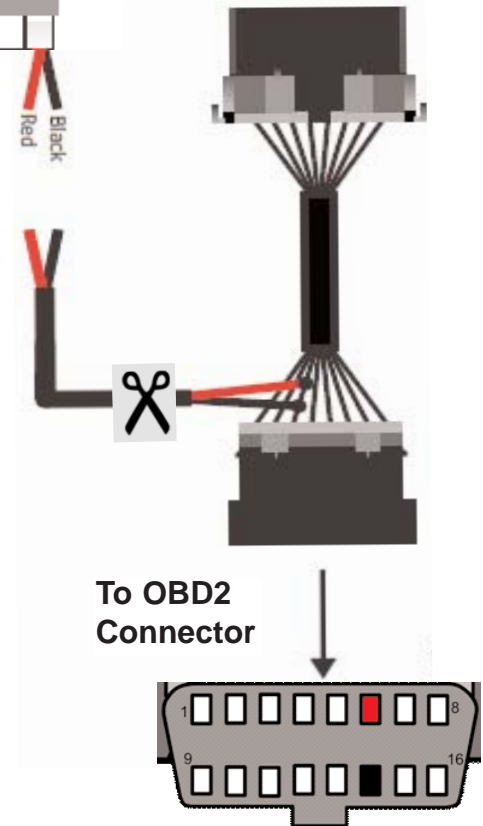

Note: Use a precision tool to press up on the backside of the OBD2 connector housing to release the tab. Push out OBD2 connector toward the back to remove.

Connect Red wire to White/Blue wire in Pin 6 and Connect Black wire to White wire in Pin 14.

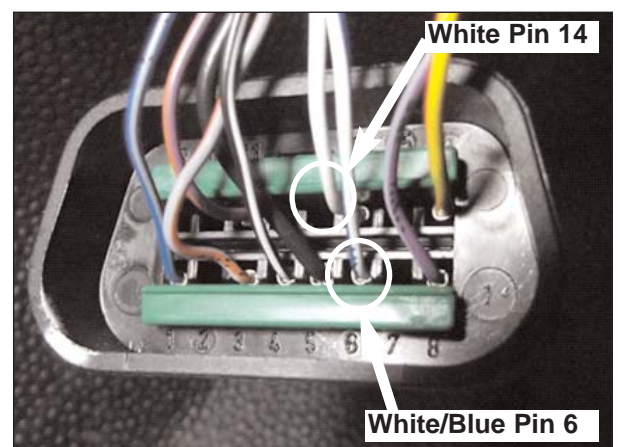
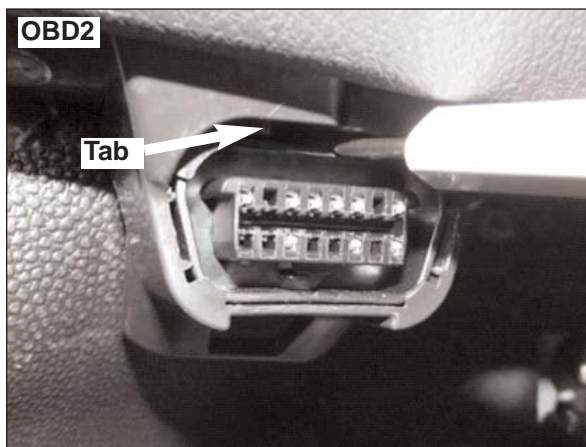



Red

### To Ignition

Note: Test the ignition wire on the vehicle before connecting Red wire from cruise system. Check for 12 volts with ignition key on and 0 volts with ignition key off.

### Ford Transit:

Connect Red ignition wire to Brown/Yellow wire at the ignition switch connector located at left side of steering column.

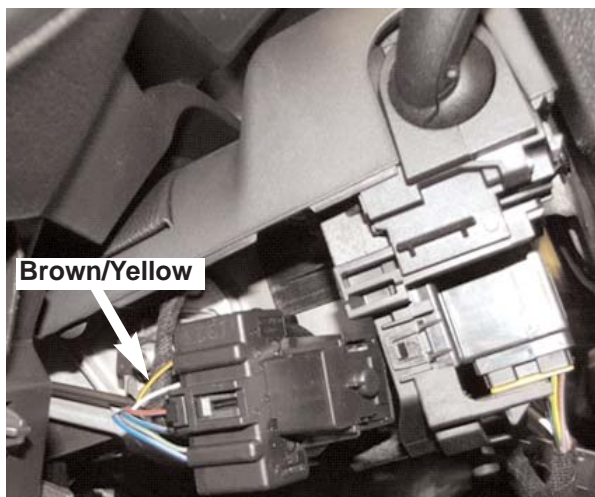

1. Find a suitable position for the switch on the left hand side of the covering around the steering column.
2. Mark the position and drill a 3/8 hole.
3. Use the enclosed fittings so the switch is angled to match the OE turn signal switch lever.
4. The switch head can be rotated as desired, and locked with the supplied retainer clip.
5. Insert the wires in the dconnectors to plug into cruise module shown below.

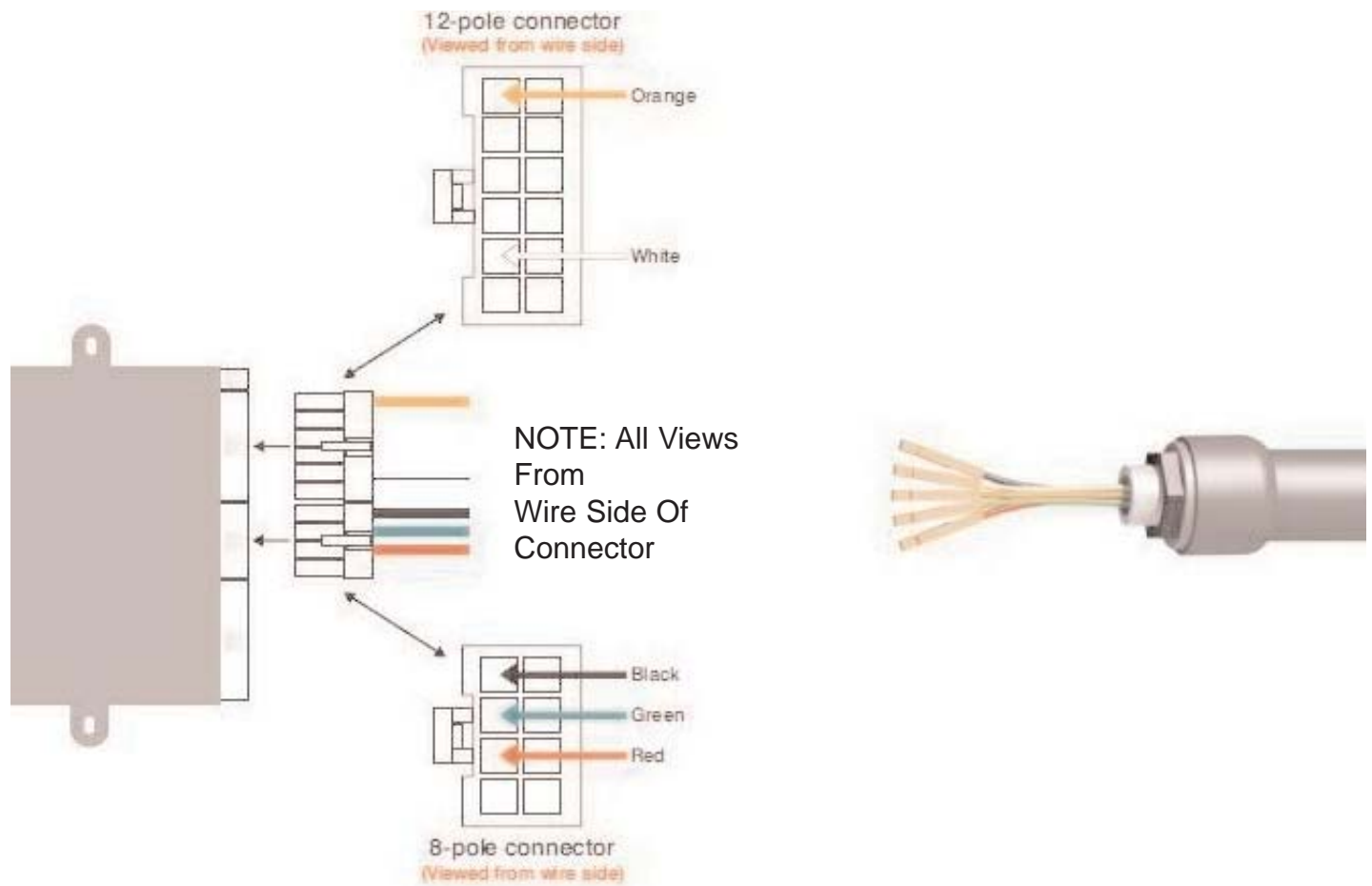

TROUBLESHOOTING

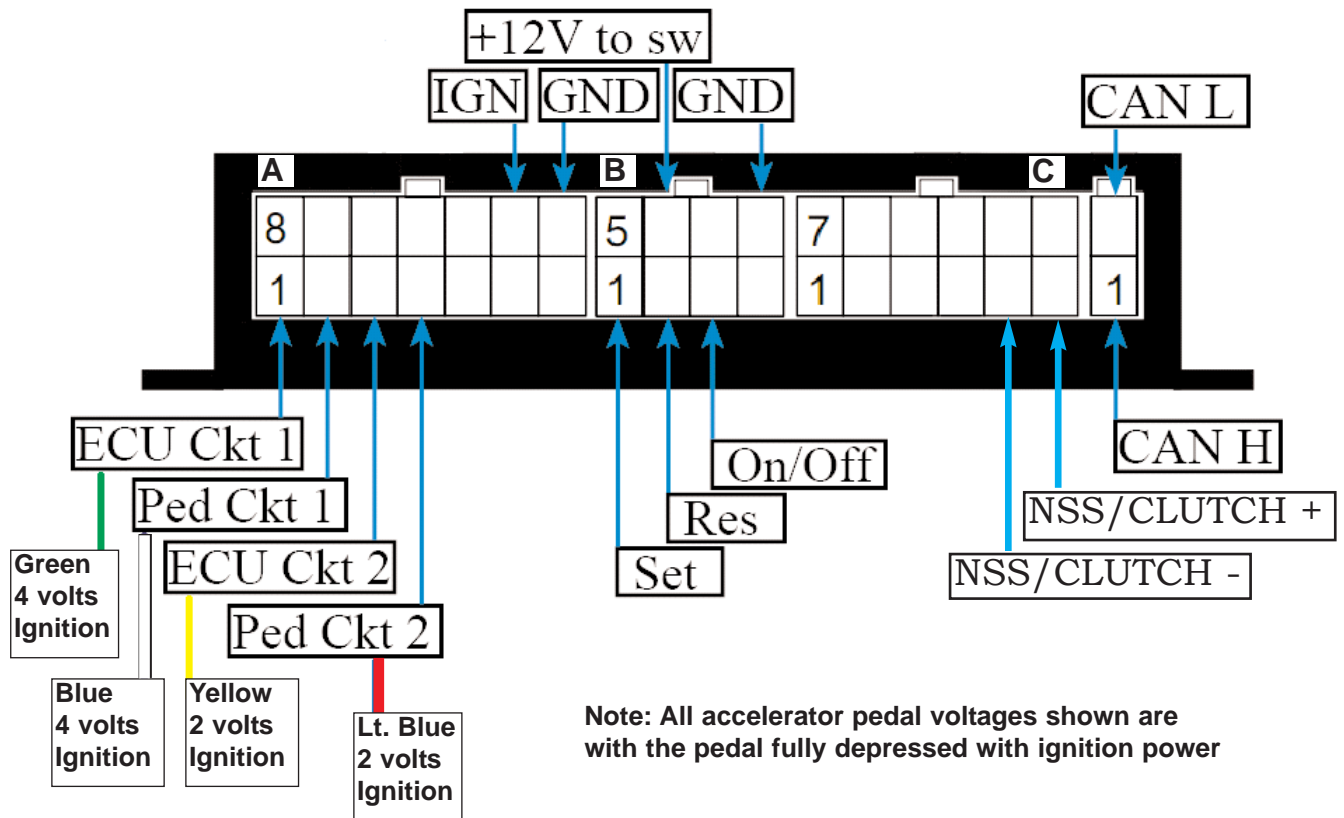

PIN	COLOR	DESIRED RESULTS	FAULT CONDITION
13A	RED	+12V WHEN SWITCHED ON AND +0V WHEN SWITCHED OFF. IGNITION MUST BE GREATER THAN +10V WHILE CRANKING VEHICLE.	NO POWER, VOLTAGE DROP, OR INTERMITTENT CONNECTION WILL CAUSE LOSS OF PEDAL OR "LIMP MODE" CONDITION.
14A	BLACK	LOWEST RESISTANCE TO GROUND AND CLOSEST TO ZERO (0) OHMS AS POSSIBLE. USE A VEHICLE GROUND POINT WHERE OTHER GROUND WIRES ARE CONNECTED.	A BAD GROUND CONNECTION WILL CAUSE THE FOLLOWING CONDITIONS: CRUISE WILL NOT FUNCTION, LOSS OF PEDAL OR "LIMP MODE" CONDITION.
1B	GREEN	SET/COAST: 12V PRESS AND HOLD SET.	CRUISE WILL NOT SET IF THIS CONNECTION IS NOT INSTALLED CORRECTLY.
2B	YELLOW	RESUME/ACCEL: 12V PRESS AND HOLD RESUME.	CRUISE WILL NOT RESUME OR ACCEL IF THIS CONNECTION IS NOT INSTALLED CORRECTLY.
3B	BROWN	ON/OFF: 12V PRESS ON.	CRUISE WILL NOT SET IF THIS CONNECTION IS NOT INSTALLED CORRECTLY.
6B	RED AND BLUE	12V	CRUISE LIGHT WILL NOT COME ON IF THESE CONNECTIONS ARE NOT INSTALLED CORRECTLY.
8B	BLACK	(0) OHMS RESISTANCE TO GROUND	CRUISE WILL NOT FUNCTION IF WRONG WIRE IS CONNECTED -OR- CRUISE WILL NOT DISENGAGE WHEN CLUTCH IS DEPRESSED.
5C	WHITE	GROUND ACTIVE WIRE AT SWITCH WHEN NSS/CLUTCH IS DEPRESSED.	
6C	YELLOW	+12V ACTIVE WIRE AT SWITCH WHEN NSS/CLUTCH IS DEPRESSED.	

