

**GENERAL APPLICABILITY**

THIS CRUISE WAS TESTED AND VERIFIED ON:  
CHEVY TRAX A/T (ALL MODELS)

**KIT CONTENTS/SERVICE PARTS**

ITEM	QTY	DESCRIPTION	PART#
1	1	CRUISE CONTROL MODULE	250-2825 AT
2	1	SWITCH HARNESS	250-2760
3	1	PEDAL INTERFACE HARNESS	250-2836
4	1	HARDWARE KIT	250-2767
5	1	CONTROL SWITCH	250-3742
6	1	DIAGNOSTICS HARNESS	250-2785

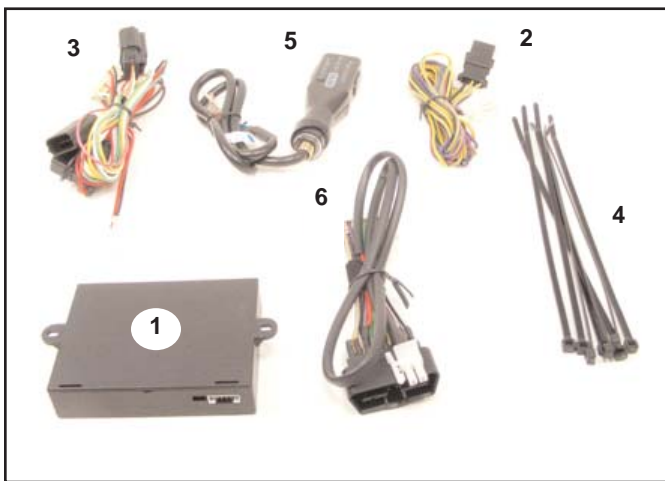

**HARDWARE BAG CONTENTS**

ITEM	QTY	DESCRIPTION
1	8	WIRE ZIP TIES
2		
3		







**RECOMMENDED TOOLS**

<b>PERSONAL &amp; VEHICLE PROTECTION</b>	
SAFETY GLASSES	
<b>SPECIAL TOOLS</b>	
VOLT-OHM METER	
<b>INSTALLATION TOOLS</b>	
TRIM REMOVAL TOOL	PHILLIPS SCREWDRIVER
10-MM WRENCH	
DRILL BITS	9.5MM OR 3/8" (FOR SWITCH)
14MM WRENCH	
SOLDERING TOOL	
<b>SPECIAL CHEMICALS</b>	

**CONFLICTS**

NOTE:

**LEGEND**

-  **STOP:** DAMAGE TO VEHICLE MAY OCCUR. DO NOT PROCEED UNTIL PROCESS COMPLIANCE HAS BEEN MET.
-  **OPERATOR SAFETY:** USE CAUTION TO AVOID RISK OF INJURY.
-  **CRITICAL PROCESS:** PROCEED WITH CAUTION TO ENSURE A QUALITY INSTALLATION. THESE POINTS WILL BE AUDITED ON A COMPLETED VEHICLE INSTALLATION.
-  **GENERAL PROCESS:** THIS HIGHLIGHTS SPECIFIC PROCESSES TO ENSURE A QUALITY INSTALLATION. THESE POINTS WILL BE AUDITED DURING THE ACCESSORY INSTALLATION.
-  **TOOLS & EQUIPMENT:** THIS CALLS OUT THE SPECIFIC TOOLS AND EQUIPMENT REQUIRED FOR THE PROCESS.
-  **REVISION MARK:** THIS MARK HIGHLIGHTS A CHANGE IN INSTALLATION WITH RESPECT TO PREVIOUS ISSUE.



**WARNING: DO NOT USE HAND-HELD 2-WAY TRANSCEIVERS INSIDE YOUR VEHICLE WHILE DRIVING.**

WHEN TRANSMITTING FROM INSIDE THE CAR, 2-WAY RADIOS THAT OPERATE IN THE 25MHZ-700MHZ FREQUENCY RANGE WITH MORE THAN 2.0 WATTS OF POWER CAN PRODUCE ELECTROMAGNETIC INTERFERENCE THAT COULD INTERFERE WITH THE OPERATION OF CRUISE AND THROTTLE CONTROLS RESULTING IN VEHICLE "LIMP MODE".

USE OF CELLULAR PHONES WILL NOT INTERFERE WITH THESE CONTROLS.



**DUE TO SENSITIVE NATURE OF SIGNALS USED FOR THIS PRODUCT, ALL NON-PLUG AND PLAY CONNECTIONS MUST BE SOLDERED. FAILURE TO COMPLY WITH THIS REQUIREMENT WILL VOID WARRANTY.**

**BEFORE INSTALLATION**

TO MAKE THE INSTALLATION EASIER, THE COMPLETE INSTALLATION INSTRUCTIONS SHOULD BE READ THROUGH BEFORE INSTALLATION IS STARTED.

THIS INSTALLATION INSTRUCTIONS CONTAINS INFORMATION HOW TO INSTALL THE ELECTRONIC CRUISE CONTROL WHICH IS NOT A Do-It-Yourself JOB.

MODERN CARS ARE EQUIPPED WITH ELECTRONICS, WHICH CAN BE COSTLY DAMAGED BY INAPPROPRIATE TREATMENT.

ROSTRA PRECISION CONTROLS CAN NOT BE HELD RESPONSIBLE FOR ANY ERROR CAUSED BY WRONG INSTALLATION

**STOP- READ BEFORE INSTALLATION  
IMPORTANT ADVISORY NOTES THAT  
YOU MUST FOLLOW**

ALWAYS DISCONNECT THE NEGATIVE CABLE FROM BATTERY BEFORE INSTALLATION.

ALWAYS USE THE ENCLOSED INSTALLATION INSTRUCTION FOR INSTALLING THE ELECTRONIC CRUISE CONTROL.

CHECK THE PART NUMBER OF THE CRUISE MODULE LABEL IS THE SAME COMPARED TO THE PART NUMBER OF THE INSTALLATION INSTRUCTIONS.

BE AWARE OF RADIO CODES THAT MIGHT HAVE TO BE TYPED IN.

FIND A LOCATION TO INSTALL THE CRUISE MODULE AND CONTROL SWITCH

IF ANY WIRES ARE LEFT, THEN CUT OFF AND INSULATE.

ONLY USE A MULTIMETER TO MEASURE VOLTAGE.

ALWAYS DRIVE THE CAR FOR A COMPLETE TEST BEFORE ASSEMBLING THE CAR.

ALL WIRE LEADS MUST BE SOLDERED.

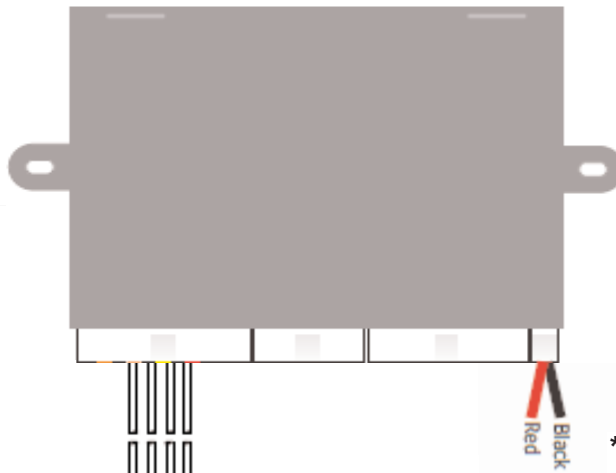
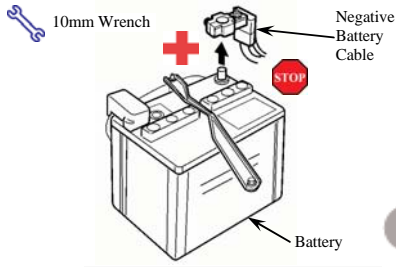

\* NOTE: IF THE OBD2 INTERFACE CONNECTOR DOES NOT FIT, OR YOU DO NOT WANT TO USE THE PLUG CAP, CUT THE ROSTRA CONNECTOR OFF AND SOLDER WIRES: RED WIRE TO PIN 6, BLACK WIRE TO PIN 14 OF OBD2 CONNECTOR IN THE VEHICLE.

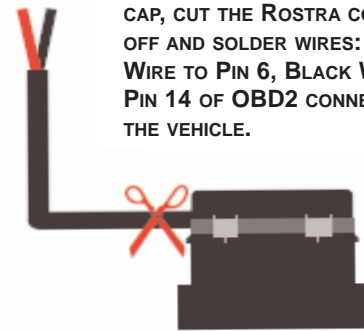

To OBD2  
CONNECTOR

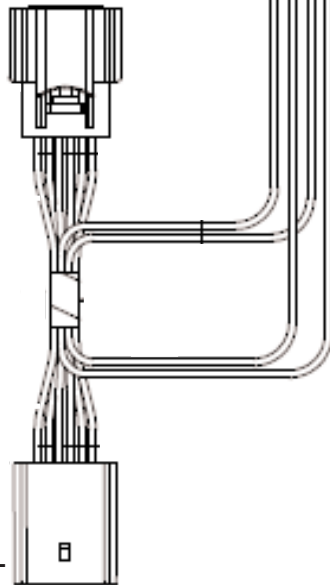
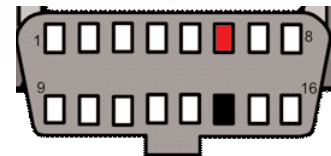

CONNECT TO THE  
ACCELERATOR PEDAL





Red

IGNITION

**CHEVROLET TRAX POWER**  
LOCATION IS IN THE IGNITION  
SWITCH HARNESS PIN POSITION 6  
VIOLET/BLACK WIRE



VIOLET/BLACK

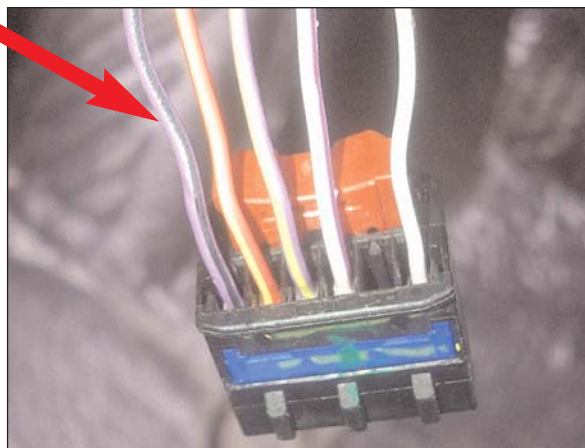

VIOLET/BLACK

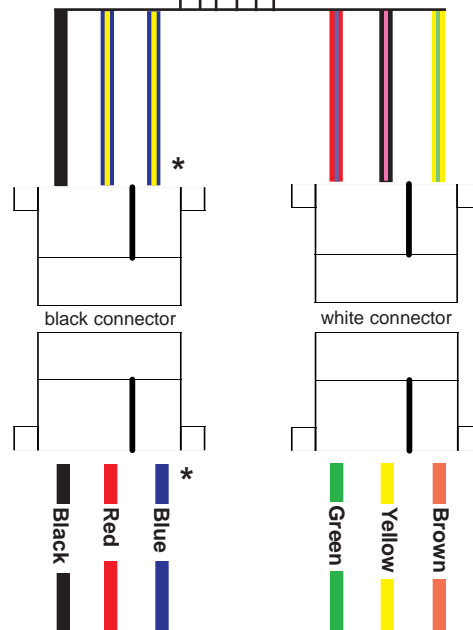

Switch Harness	Rostra Switch
BLACK	BLACK
BLUE/YELLOW	RED
BLUE/YELLOW*	BLUE*
RED/PURPLE	GREEN
BLACK/PURPLE	YELLOW
YELLOW/GREEN	BROWN

\* Both Blue/Yellow wires are spliced together. Just connect one BLU/YEL wire to the BLUE, and the other to the RED. The order does not matter.



**Do not drill hole for control switch before testing the cruise system**

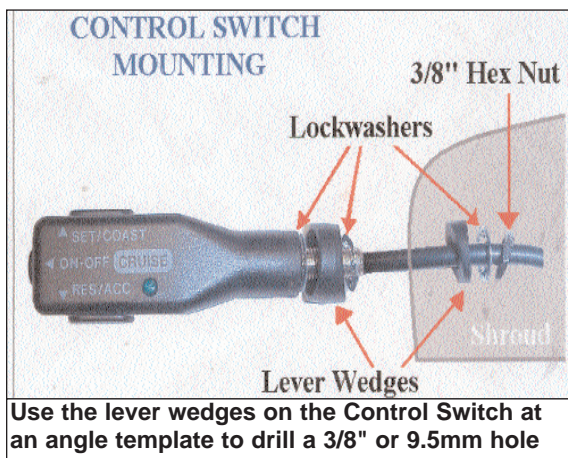

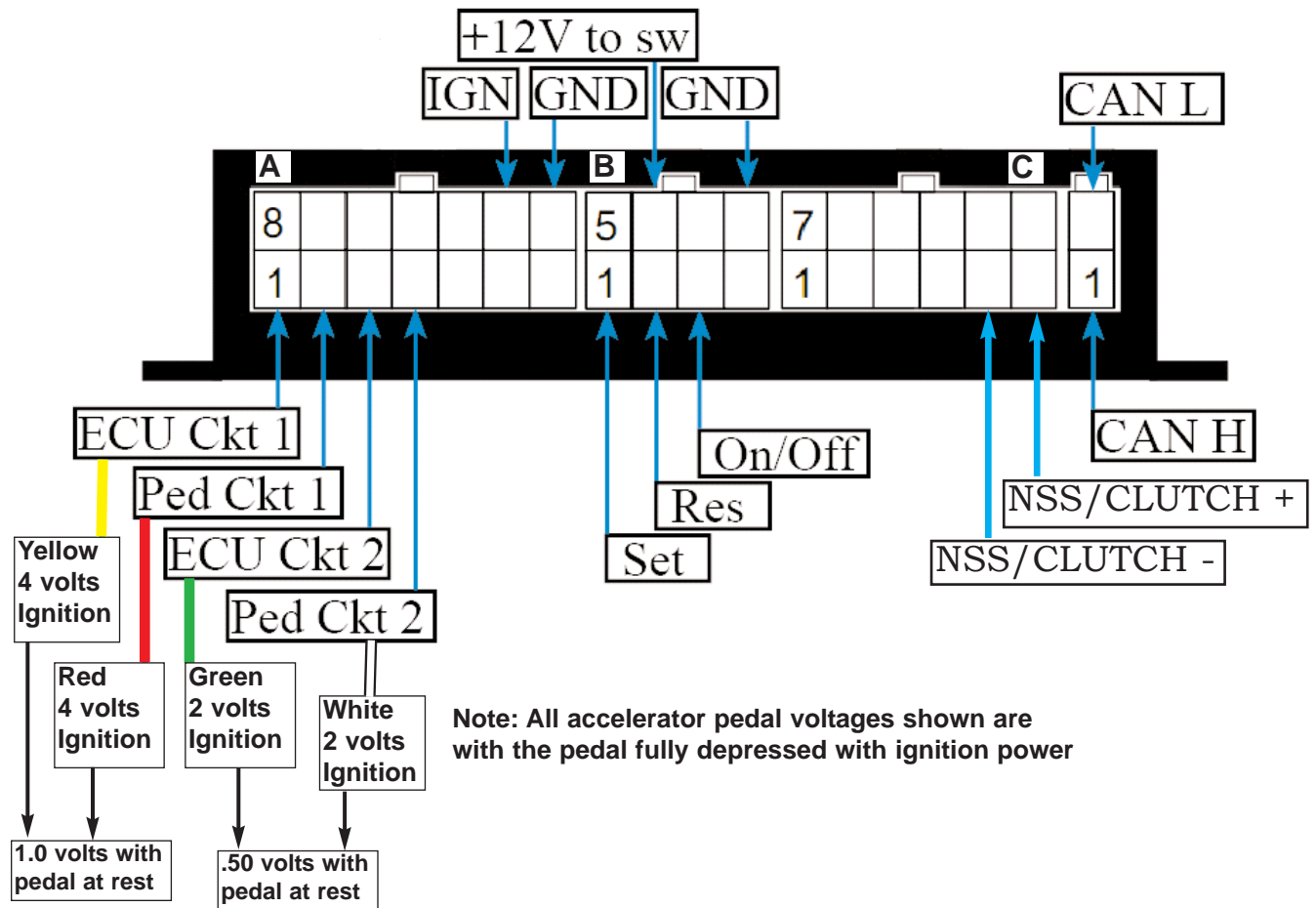

PIN	COLOR	DESIRED RESULTS	FAULT CONDITION
13A	RED	+12V WHEN SWITCHED ON AND +OV WHEN SWITCHED OFF. IGNITION MUST BE GREATER THAN +10V WHILE CRANKING VEHICLE.	NO POWER, VOLTAGE DROP, OR INTERMITTENT CONNECTION WILL CAUSE LOSS OF PEDAL OR "LIMP MODE" CONDITION.
14A	BLACK	LOWEST RESISTANCE TO GROUND AND CLOSEST TO ZERO (0) OHMS AS POSSIBLE. USE A VEHICLE GROUND POINT WHERE OTHER GROUND WIRES ARE CONNECTED TO.	A BAD GROUND CONNECTION WILL CAUSE THE FOLLOWING CONDITIONS: CRUISE WILL NOT FUNCTION, LOSS OF PEDAL OR "LIMP MODE" CONDITION.
1B	GREEN	SET/COAST: 12V PRESS AND HOLD SET	CRUISE WILL NOT SET IF THIS CONNECTION IS NOT INSTALLED CORRECTLY.
2B	YELLOW	RESUME/ACCEL: 12V PRESS AND HOLD RESUME	CRUISE WILL NOT RESUME OR ACCEL IF THIS CONNECTION IS NOT INSTALLED CORRECTLY.
3B	BROWN	ON/OFF: 12V PRESS ON	CRUISE WILL NOT SET IF THIS CONNECTION IS NOT INSTALLED CORRECTLY.
6B 8B	RED AND BLUE BLACK	12V (0) OHMS RESISTANCE TO GROUND	CRUISE LIGHT WILL NOT COME ON IF THESE CONNECTIONS ARE NOT INSTALLED CORRECTLY.

NOTES:

