

# **VEHICLE TECHNICAL INFORMATION GUIDE FOR CRUISE CONTROL**

**MODEL YEARS: 1986-1995**

2519 Dana Drive  
Laurinburg, NC 28352  
Technical Service (910) 277-1828, Fax (910) 276-3759  
Fax Back System (910) 610-4191  
Web Site @ [www.Rostra.Com](http://www.Rostra.Com)

**WARNING:**



The information presented in this manual has been carefully compiled through actual vehicle testing and manufacturers service manual research and to the best of our ability is accurate.

However, we do not warrant the accuracy of this information against changes in vehicle design, the use or misuse of this information or typographical errors.

It is the responsibility of installer to verify the signal and color on the wire attachments prior to and after the installation of the cruise control to assure proper operation of the cruise control and the vehicle through a road test.

We do not accept any responsibility for damage to the vehicle or injury to its occupants caused by the use of this information. Connection to the incorrect wires could cause cruise control or vehicle malfunctions and component damage. These conditions can cause a major risk while driving for you, your passengers and other motorists, exposing all of you to the risk of accident and injury.

**WARNING:**



Any installation of a cruise control on a vehicle that does not have clearance at the throttle for lost motion or may have interference by other parts must have the cruise control cable attached to the accelerator pedal for obvious safety reasons.

**CAUTION:**

Any installation of a cruise control on a vehicle with an accelerator pedal activated switch for emissions or transmission shifting must have the cruise control cable attached to the accelerator pedal for proper vehicle operation.

**NOTE: VEHICLE MANUFACTURERS WILL OCCASIONALLY CHANGE WIRE COLOR BUT RARELY CHANGE POSITION OF THE VSS WIRE.**

# INDEX

HOW TO USE THIS GUIDE .....	Page 4
WIRE ATTACHMENT LOCATION CHART.....	Page 5
* CHRYSLER CORP. Chrysler, Dodge, Jeep, Eagle & Plymouth .....	Page 6
* PRE-1992 CHRYSLER CORP .....	Pages 14-15
* FORD MOTOR COMPANY Ford & Mercury.....	Page 16
* PRE-1992 FORD MOTOR COMPANY .....	Pages 20-21
*GENERAL MOTORS Buick, Chevrolet, GEO, GMC, Oldsmobile, Pontiac & Saturn.....	Page 22
* PRE-1992 GENERAL MOTORS .....	Pages 36-39
*HONDA.....	Page 40
*HYUNDAI.....	Page 40
*PRE-1992 HYUNDAI .....	Pages 48-49
*KIA.....	Page 40
*ISUZU.....	Page 42
*MAZDA.....	Page 44
*PRE-1992 MAZDA.....	Page 46
*MITSUBISHI.....	Page 48
*PRE-1992 MITSUBISHI .....	Pages 48-49
*NISSAN.....	Page 50
*PRE-1992 NISSAN.....	Pages 52-53
*SUBARU.. .....	Page 54
*SUZUKI.... .....	Page 54
*TOYOTA.....	Page 54
*TOYOTA.....	Page 58
*VOLKSWAGON .....	Page 59

\*NOTE: Vehicle Speed Sensor Wire location on vehicles prior to 1992, must be matched by visual comparison to the diagrams at the back of each manufacturer's section.

## HOW TO USE THIS GUIDE

- I Locate the manufacturer of the vehicle in which this Cruise control kit is being installed in the index on page 3.
- II Locate the manufacturer, model, & engine size that is appropriate to this application in columns A & B.
- III Column C gives the appropriate Custom Control Switch
- IV Column D gives the wire attachment location code for VSS that corresponds to the wire attachment chart on page 5. This column also gives the wire position within that location.
- V Column E gives the vehicle VSS wire color.
- VI Column F gives the vehicle VSS pulses per mile.
- VII Column G Gives the wire attachment location code for tachometer signal that corresponds to the wire attachment chart on page 5. This column also gives the wire position within that location.
- VIII Column H gives the vehicle tachometer wire signal color.
- IX Column I gives the vehicle brake switch positive side wire color.
- X Column J gives the vehicle brake switch negative side wire color.

### **ADDITIONAL ACCESSORIES:**

<b>250-4115</b>	<b>VACUUM REGULATOR</b>
<b>250-4156</b>	<b>UNIVERSAL CLUTCH SWITCH WITH DUMP VALVE</b>
<b>250-6019</b>	<b>VACUUM RESERVOIR CANISTER, 35 CU. IN.</b>
<b>250-3417</b>	<b>VACUUM RESERVOIR CANISTER, 20 CU. IN.</b>
<b>250-4206</b>	<b>UNIVERSAL DISENGAGEMENT SWITCH, 10MM</b>

**NOTE: Vehicle Speed Sensor Wire location on vehicles prior to 1992, must be matched by visual comparison to the diagrams at the back of each manufacturer's section.**



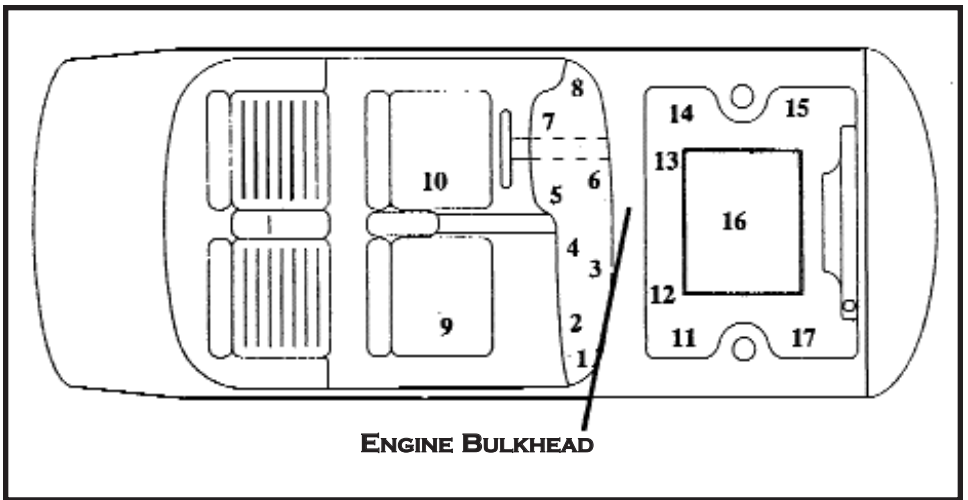

- LOCATION 1: ABOVE OR BEHIND PASSENGER'S SIDE KICK PANEL.
- LOCATION 2: BEHIND PASSENGER'S SIDE DASH AND/OR GLOVE BOX.
- LOCATION 3: BOTTOM OF DASH PANEL BETWEEN CENTER CONSOLE & GLOVE BOX.
- LOCATION 4: CENTER CONSOLE (PASSENGER'S SIDE ACCESS).
- LOCATION 5: CENTER CONSOLE (DRIVER'S SIDE ACCESS).
- LOCATION 6: RIGHT HAND SIDE OF STEERING COLUMN.
- LOCATION 7: BEHIND INSTRUMENT PANEL AND/OR LEFT HAND SIDE OF STEERING COLUMN.
- LOCATION 8: ABOVE OR BEHIND DRIVER'S SIDE KICK PANEL.
- LOCATION 9: UNDER PASSENGER'S SIDE SEAT.
- LOCATION 10: UNDER DRIVER'S SIDE SEAT.
- LOCATION 11: PASSENGER'S SIDE FENDER WELL (BETWEEN ENGINE BULKHEAD & SHOCK TOWER).
- LOCATION 12: PASSENGER'S SIDE ENGINE BULKHEAD
- LOCATION 13: DRIVER'S SIDE ENGINE BULKHEAD
- LOCATION 14: DRIVER'S SIDE FENDER WELL (BETWEEN ENGINE BULKHEAD & SHOCK TOWER).
- LOCATION 15: DRIVER'S SIDE FENDER WELL (BETWEEN SHOCK TOWER & FRONT GRILL).
- LOCATION 16: ON ENGINE
- LOCATION 17: PASSENGER'S SIDE FENDER WELL (BETWEEN SHOCK TOWER & FRONT GRILL).

# CHRYSLER, DODGE, JEEP, EAGLE & PLYMOUTH

Vehicle Year	A Vehicle Manufacturer	B Vehicle Model & Engine Size	C Control Switch/ Throttle Adaptor		D Cruise Control Gray Wire Attachment For VSS Signal
95	Chrysler	Cirrus	250-3421		Position 66 of PCM located at driver's fender side shield (next to Power Distribution Center)
92 93/94	Chrysler	Lebaron	250-3421		Loc 13 Wire Harness from Transmission Loc 15 Dark Gray 10 pin plug rear of battery
92 93/94	Chrysler	Town & Country	250-3421		Location 13 Wire Harness from Transmission
95	Chrysler	Town & Country 2.5L & 3.0L	250-3421		Loc 13 Black 3 pin conn. at left rear of transmission or Pos. 47 of PCM (Loc 15)
95	Chrysler	Town & Country 3.3L & 3.8L	250-3421		Location 15 Black 4 pin conn at rear of battery or Position 47 of PCM (Location 15)
92 93/94/95	Dodge	*Colt	250-3421		Location 1 Largest Connection in ECM Location 1 22 pin connector of ECM
92 93/94/95	Dodge	*Colt Vista	250-3421		Location 1 Largest Connection in ECM Location 1 22 pin connector of ECM
92 93/94	Dodge	Daytona 2.5L & 3.0L	250-3421		Loc 13 Wire Harness from Transmission Loc 15 Dk. Gray 10 pin plug rear of battery
92	Dodge	Dynasty	250-3421		Location 13 Wire Harness from Transmission
93 94	Dodge	Dynasty 2.5L	250-3421		Location 15 Black 4 Pin Plug Rear of Battery
93 94	Dodge	Dynasty 3.0L	250-3421		Location 15 Black 4 pin Plug Rear of Battery
93 94/95	Dodge	Intrepid	250-3421		Loc 15 Pos 47 of PCM or Pos 58 of Transmission Control Module in Loc 17
95	Dodge/ Plymouth	Neon 2.0L	250-3421		Location 15 Position 5 of PCM
92 93/94	Dodge	Shadow 2.2L & 2.5L	250-3421		Loc 13 Wire Harness from Transmission Loc 15 Dk. Gray 10 Pin Plug Rear of Battery
93/94	Dodge	Shadow 3.0L	250-3421		Loc 14 Dk. Gray 10 pin plug rear of battery

\*VEHICLES SOLD BY CHRYSLER, BUILT BY MITSUBISHI, WITH AUTOMATIC TRANSMISSION ARE TO BE A PEDAL PULL.

# CHRYSLER, DODGE, JEEP, EAGLE & PLYMOUTH

<b>E</b> Vehicle VSS Wire Color	<b>F</b> VSS Pulses	<b>G</b> Cruise Control Blue Wire Attachment For Tach Signal	<b>H</b> Vehicle Tach Wire Color	<b>I</b> Brake Switch Positive	<b>J</b> Brake Switch Negative
White/Orange	8000	Location 15 - 40 pin conn (41-80) Position 60	White/ Black	Red/Black	White/Tan
White/Orange	8000	Location 16 Ignition Coil Loc15 10 Pin Black Plug Rear of Battery	Black/Gray	Pink/ Dk. Blue	White/Tan
White/Orange	8000	Location 16 Ignition Coil	Black/Gray	Pink/ Dark Blue	White/Tan
White/Orange	8000	Loc 16 distributor/ignition coil at center of engine or position 19 of PCM	Black/Gray	Pink/ Dk. Blue	White/Tan
White/Orange	8000	Loc 16 distributor/ignition coil at center of Plenum or position 19 of PCm	Black/Gray	Pink/ Dk.Blue	White/Tan
Yellow/White	4000	Loc 16 2 pin conn at Fuel Rail Loc 1 26 pin conn Position 10	White	White/Red	Green
Yellow/White	4000	Loc 16 between Intake & CAM Cover Loc 1 26 pin conn Position 10	White	Red	Green
White/Orange	8000	Loc 16 Ignition Coil Loc 15 10 pin Black plug rear of battery	Black/Gray	Pink/ Dark Blue	White/Tan
White/Orange	8000	Location 16 Ignition Coil	Black/Gray	Pink/ Dark Blue	White/Tan
White/Orange	8000	Loc 16 Black 6 pin plug front of engine	Gray	Pink/ Dark Blue	White Tan
White/Orange	8000	Loc 15 Black 10 pin plug rear battery	Gray	Pink/ Dark Blue	White/Tan
White/Orange	8000	Loc 16 ignition coil also Pos 19 of PCM	Gray	Pink/ Dark Blue	White/Tan
White/Orange	8000	Loc 15 Position 48 of PCM	Gray	Pink/ Dk. Blue	White/Tan
White/Orange	8000	Loc 16 Ignition Coil Loc 15 10 pin Black Plug Rear of Batter	Gray	Pink	White
White/Orange	8000	Loc 15 Black 10 plug rear of batter	Gray	Pink/ Dk. Blue	White/Tan

# CHRYSLER, DODGE, JEEP, EAGLE & PLYMOUTH

Vehicle Year	A Vehicle Manufacturer	B Vehicle Model & Engine Size	C Control Switch/ Throttle Adaptor		D Cruise Control Gray Wire Attachment For VSS Signal
92 93/94/95	Dodge	Spirit 2.5L & 3.0L	250-3421		Loc 13 Wire Harness from Transmission Loc 15 Dk. Gray 10 pin plug rear of battery
92	Dodge	*Stealth 3.0L	250-3421		Loc 5 26 pin connector of ECM Pos 18
92	Dodge	*Stealth 3.0L DOHC	250-3421		Loc 5 22 pin connector of ECM Pos 66
94	Dodge	*Stealth	250-3421		Loc 5 22 pin connector of ECM
92 93/94	Dodge Trucks	Caravan 2.5L & 3.0L	250-3421		Loc 13 Wire Harness from Transmission
95	Dodge	Caravan 2.5L & 3.0L	250-3421		Loc 13 Black 3 pin conn at left rear of transmission or pos 47 of PCM (Loc 15)
92/93	Dodge	Caravan 3.3L	250-3421		Loc 13 Wire Harness from Transmission
94	Dodge	Caravan 3.3L	250-3421		Block 10 pin connector at rear of battery
95	Dodge	Caravan 3.3L & 3.8L	250-3421		Loc 15 Black 4 pin conn at rear of battery or Pos 47 of PCM (Loc 5)
95	Dodge	Dakota 2.5L, 3.9L & 5.2L	250-3421		Loc 13 Wire Harness from Transmission
95	Dodge	Dakota 2.5L	250-3421		Loc 13 in 3 pin conn at left rear of transmission or position 47 of PCM (Location 5)
95	Dodge	Dakota 3.9L & 5.2L	250-3421		Loc 13 in 3 pin conn at left rear of transmission or Pos 47 of PCM (Loc 15)
92 93/94	Dodge	Pick-up 3.9L, 5.2L & 5.9L	250-3421		Loc 13 Wire Harness from Transmission
95	Dodge	Pick-up 3.9L, 5.2L & 5.9L	250-3421		3 pin conn at rear of transmission or Pos 47 of PCM(right side of dash panel)
92 93/94	Dodge	Pick-up Cummings Diesel	250-3421		Loc 13 Wire Harness from transmission

\*VEHICLES SOLD BY CHRYSLER, BUILT BY MITSUBISHI, WITH AUTOMATIC TRANSMISSION ARE TO BE A PEDAL PULL.

# CHRYSLER, DODGE, JEEP, EAGLE & PLYMOUTH

E Vehicle VSS Wire Color	F VSS Pulses	G Cruise Control Blue Wire Attachment For Tach Signal	H Vehicle Tach Wire Color	I Brake Switch Positive	J Brake Switch Negative
White/Orange	8000	Location 16 Ignition Coil	Black/Gray	Pink/ Dk. Blue	White/Tan
Yellow/White	4000	Location 16 beside Intake-Distributor end	White	Red/Black	Green
Yellow/White	4000	Location 16 near Multi-coil	White	Red/Black	Green
Yellow/White	4000	Location 5 26 pin conn of ECM	White	Red/Black	Green
White/Orange	8000	Location 16 Ignition Coil	Black/Gray	Pink/ Dk. Blue	White/ Tan
White/Orange	8000	Loc 16 Distributor/Ignition coil at center of engine or Pos 19 of PCM	Black/Gray	Pink/ Dk.Blue	White/Tan
White/Orange	8000	Location 16 Ignition Coil Pack	Black/Gray	Pink/ Dk.Blue	White/Tan
White/Orange	8000	Location 16 right rear of engine ignition coil	Black/Gray	Pink/ Dk.Blue	White/Tan
White/Orange	8000	Loc 16 Distributor/Ignition coil at rear of plenum or Pos 19 of PCM	Black/Gray	Pink/ Dk. Blue	White/Tan
White/Orange	8000	Location 16 Ignition Coil	Gray/Black Gray	Pink	White
White/Orange	8000	Loc 16 Distributor/Ignition Coil on Thermostat Housing or Pos 19 of PCM	Gray	Pink/ Dk. Blue	White/Tan
White/Orange	8000	Loc 16 Distributor/Ignition Coil at right of engine or Pos 19 of PCM	Gray	Pink/ Dk.Blue	White/Tan
White/Orange	8000	Location 16 Ignition Coil	Gray	Pink/ Dk.Blue	White/Tan
White/Orange	8000	Loc 16 Ignition Coil on right front of engine of Pos 19 of PCM	Black/Gray	Pink/ Dk.Blue	White/Tan
White/Orange	8000	If manual transmission Use 250-4206	N/A	Pink/ Dk.Blue	White/Tan

# CHRYSLER, DODGE, JEEP, EAGLE & PLYMOUTH

Vehicle Year	A Vehicle Manufacturer	B Vehicle Model & Engine Size	C Control Switch/ Throttle Adaptor		D Cruise Control Gray Wire Attachment For VSS Signal
95	Dodge	Pick-up Cummings Diesel	250-3421		3 pin conn at rear of transmission or Pos 47 of PCM (right side of dash panel)
92	Dodge	*Ram 50 2.4L	250-3421		Location 1 Largest Connector of ECM
93	Dodge	Ram 50 2.4L & 3.0L	250-3421		Location 4 in 18 pin conn of ECM
92 93/94	Dodge	Ram Charger 5.2L & 5.9L	250-3421		Loc 13 Wire Harness from transmission
92 93 94	Dodge	Van 3.9L, 5.2L & 5.9L	250-3421		Loc13 Black 10pin conn at rear of engine Loc13 White 16pin conn at rear of engine Position 11
95	Dodge	Van 3.9L, 5.2L & 5.9L	250-3421		Loc 13 3 pin conn at left rear of transmission or Pos 47 of PCM (Location between 12 & 13)
94	Dodge	RWD Vans	250-3421		Loc (under Hood) PCM near Wiper Motor
92 93/94/95	Eagle	*Summit	250-3421		Loc 1 Largest connector of ECM Loc 1 22 pin conn of ECM
92 93/94	Eagle	*Talon	250-3421		Loc 4 Largest connector of ECM Loc 4 24 pin conn of MFI, Pos. 18
95	Eagle	Talon	250-3421		Loc 5 pos. 14 of 16 pin data link conn.
93	Eagle	Vision	250-3421		Loc 15 Pos. 47 of PCM
92 93/94/95	Jeep	Cherokee 2.5L & 4.0L	250-3091		Loc 13 Wire Harness form Transmission
92	Jeep	Comanche 2.5L & 4.0L	250-3421		Loc 13 Wire Harness form Transmission
94/95	Jeep	Grand Cherokee	250-3421		Loc 13 Wire Harness from Transmission
92 93/94/95	Jeep	Wrangler 2.5L & 4.0L	250-3091		Loc 12 Wire Harness from Transmission

\*VEHICLES SOLD BY CHRYSLER, BUILT BY MITSUBISHI, WITH AUTOMATIC TRANSMISSION ARE TO BE PEDAL PULL

# CHRYSLER, DODGE, JEEP, EAGLE & PLYMOUTH

E Vehicle VSS Wire Color	F VSS Pulses	G Cruise Control Blue Wire Attachment For Tach Signal	H Vehicle Tach Wire Color	I Brake Switch Positive	J Brake Switch Negative
White/Orange	8000	If manual transmission Use 250-4206	N/A	Pink/ Dk. Blue	White/Tan
Yellow/White	4000	Location 16 Ignition Coil	Blue	Pink	White
Yellow/White	4000	Location 16 Ignition Coil	Black/White	Pink	White
White/Orange	4000	Location 16 Ignition Coil	Black/White	Pink	White
White/Orange White/Orange	8000	Loc 16 Beside Intake-Distributor End or near Multi Coil	Black/Gray Gray	Pink	White
White/Orange	8000	Loc 16 Ignition Coil or Pos 19 of PCM	Gray	Pink/ Dk. Blue	White
White/Orange	8000	Location (PCM under Hood) Position 19	Gray	Pink	White
Yellow/White	4000	Loc 16 2 wire conn at Fuel Rail Loc 1 26 pin conn at ECM, Pos 10	White	White/ Red	Green
Yellow/White	4000	Loc 16 tach Filter Loc 4 10 pin conn or MFI	White	Green/ White	Green
Yellow/White	4000	Loc 16 connector on driver's side engine	Turbo-Blk/White Non-Turbo- Black/Red	Red/Black	Green
White/Orange	8000	Loc 16 Ignition Coil also Pos 19 of PCM	Gray	Pink/ Dk. Blue	White/Tan
White or White/Orange	8000	Loc 16 Ignition Coil	Gray or Gray/Black	Pink/ Black	White/Tan
White or White/Orange	8000	Loc 16 Ignition Coil	Gray	Pink/ Black	White/Tan
White/Orange	8000	Loc 16 Ignition Coil	Gray or Gray/Black	Pink/ Dk. Blue	White/Tan
Blue	8000	Loc 16 Ignition Coil	Yellow/Black Gray or Gray/Black	Pink/ Dk. Blue	White/Tan

NOTE: On 1991 to present Chrysler vehicles, you can find Tach (Pos.19 - Gray or Black w/Gray and VSS-8000ppm at (Pos.47 - White w/Orange) at Power Train Module located at left fender side shield

# CHRYSLER, DODGE, JEEP, EAGLE & PLYMOUTH

Vehicle Year	A Vehicle Manufacturer	B Vehicle Model & Engine Size	C Control Switch/ Throttle Adaptor		D Cruise Control Gray Wire Attachment For VSS Signal
92 93/94/95	Plymouth	Acclaim 2.5L	250-3421		Loc 13 Wire Harness from Transmission Loc 15 Dk Gray 10 pin plug rear of Battery
92 93/94/95	Plymouth	Colt 1.5L & 2.0L	250-3421		Loc 1 Largest Connector of ECM Loc 1 22 pin connector of ECM
93/94 95	Plymouth	Concord	250-3421		Loc 15 pos 47 of PCM Loc 15 pos 47 of PCM or pos 58 of TCM in Loc 17
92 93/94	Plymouth	*Laser 1.8L	250-3421		Loc 4 Largest Connector of ECM Loc 4 24 pin conn of MFI Control, Pos 18
95	Dodge	Stratus	250-3421		Pos 66 of PCM at driver's fender side shield (next to Power Distribution Center)
92	Plymouth	Sundance 2.2L Duster	250-3421		Loc 13 Wire Harness from Transmission
93	Plymouth	Sundance Duster 2.2L & 3.0L	250-3421		Loc 15 Dk. Gray 10 pin plug rear of battery
92 93/94	Plymouth	Sundance 2.5L Duster	250-3421		Loc 13 Wire Harness from Transmission Loc 15 Dk. Gray 10 pin plug rear of battery
92 93/94	Plymouth	Voyager 2.5L & 3.0L	250-3421		Loc 13 Wire Harness from Transmission
95	Plymouth	Voyager 2.5L & 3.0L	250-3421		Loc 13 Black 3 pin conn at left rear of Transmission or Pos 47 of PCM (Location 15)
92	Plymouth	Voyager 3.3L	250-3421		Loc 13 Wire Harness from Transmission
93 94	Plymouth	Voyager 3.3L	250-3421		Black 10 pin connector at rear of battery
95	Plymouth	Voyager 3.3L & 3.8L	250-3421		Loc 15 Black 4 pin conn at rear of battery or Pos 47 of PCM (Loc 15)

\*VEHICLES SOLD BY CHRYSLER, BUILT BY MITSUBISHI, WITH AUTOMATIC TRANSMISSION ARE TO BE PEDAL PULL



# CHRYSLER, DODGE, JEEP, EAGLE & PLYMOUTH

E Vehicle VSS Wire Color	F VSS Pulses	G Cruise Control Blue Wire Attachment For Tach Signal	H Vehicle Tach Wire Color	I Brake Switch Positive	J Brake Switch Negative
White/Orange		Location 16 Ignition Coil	Negative Side	Pink/ Blue	White/Tan
Yellow/White	8000	Location 16 Ignition Coil Location 15 10 pin Black plug rear of battery	Black/Gray	Pink/ Dk.Blue	White/Tan
White/Orange	8000	Location 16 Ignition Coil or Position 19 of PCM	Gray	Pink/ Dk.Blue	White/Tan
Yellow/White	4000	Location 16 Tach Filter Location 4 10 pin conn MFI	White	Green/ White	Green
White/Orange	8000	Location 15 40 pin conn (41-80) Position 60	White/ Black	Red/ Black	White/Tan
White/Orange	8000	Location 16 Ignition Coil	Gray	Pink	White
White/Orange	8000	Location 15 Black 10 pin plug rear of battery	Gray	Pink/ Blue	White/Tan
White/Orange	8000	Location 16 Ignition Coil Location 15 Black 10 pin plug rear of battery	Gray	Pink Pink/ Dk.Blue	White White/Tan
White/Orange	8000	Location 16 Ignition Coil	Black/ Gray	Pink/ Dk.Blue	White/Tan
White/Orange	8000	Loc 16 Distributor/Ignition coil at center of engine or Pos 19 of PCM	Black/ Gray	Pink/ Dk.Blue	White/Tan
White/Orange	8000	Location 16 Coil Pack	Black/ Gray	Pink/ Dk.Blue	White/Tan
White/Orange	8000	Loc 16 Ignition Coil right rear of Engine	Black/ Gray	Pink/ Dk.Blue	White/Tan
White/Orange	8000	Loc 16 Distributor/Ignition Coil at rear of plenum or Pos 19 of PCM	Black/ Gray	Pink/ Dk.Blue	White/Tan

NOTE: On 1991 to present Chrysler vehicles, you can find Tach (Pos.19 - Gray or Black w/Gray and VSS-8000ppm at (Pos.47 - White w/Orange) at Power Train Module located at left fender side shield

The figures below are to assist in locating VSS positions. All pre-1992 applications must be matched by visual comparison only.

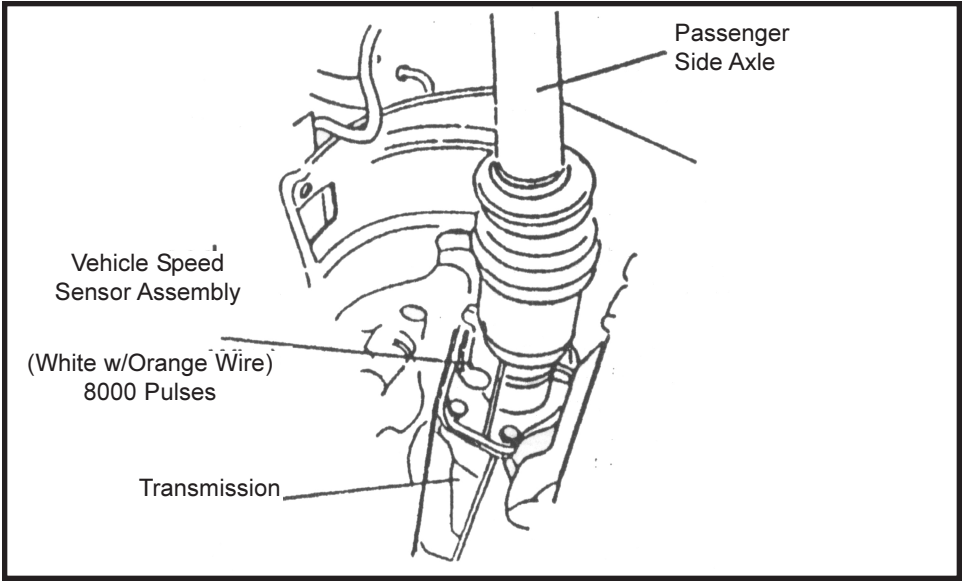

**FIGURE 1**  
**View From Under Side of Vehicle**  
**(Front wheel drive vehicle shown)**

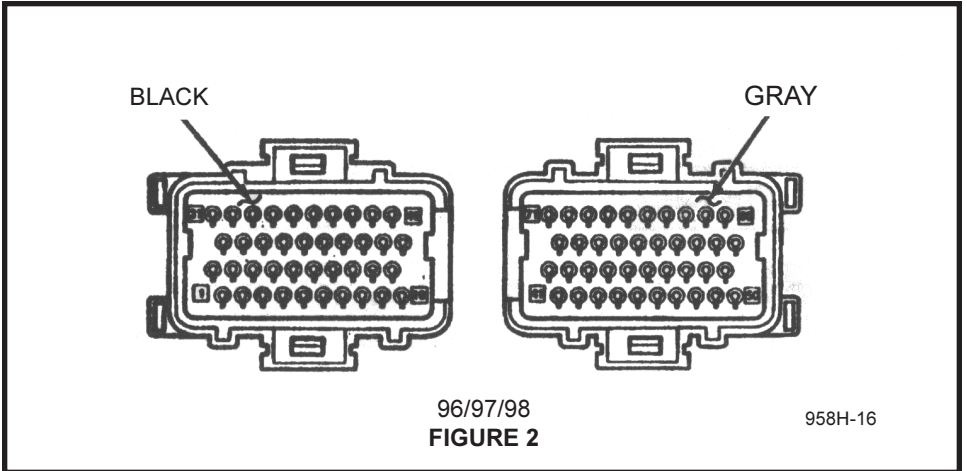

96/97/98  
**FIGURE 2**

958H-16

# CONNECTOR HOUSING DIAGRAMS

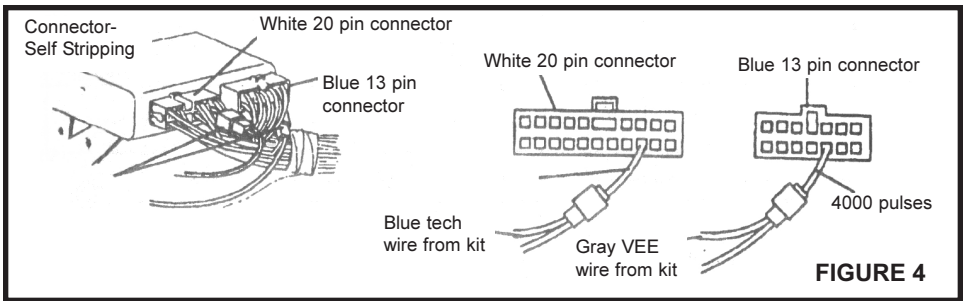
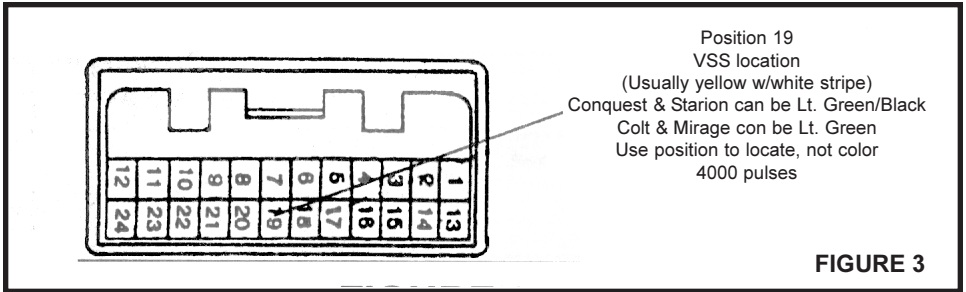

# FORD & MERCURY

Vehicle Year	A Vehicle Manufacturer	B Vehicle Model & Engine Size	C Control Switch/ Throttle Adaptor		D Cruise Control Gray Wire Attachment For VSS Signal
95	Ford	Aspire	250-3421		Location 6 Pos 5 of 22 pin conn, top row
95	Ford & Mercury	Contour & Mystique	250-3421	250-4241	Loc 13 Remove air cleaner assembly; 2 wire connector on top of transaxle
92 93/94/95	Ford & Mercury	Escort & Tracer	250-3421		Loc 13 Wire Harness from Transmission
92 93/94	Ford & Mercury	LTD & Grand Marquis	250-3421		Loc 13 Wire Harness from Transmission
95	Ford & Mercury	Crown Victoria & Grand Marquis	250-3421		Pos 58 of Gray 103 pin conn of PCM
92 93	Ford	Mustang 2.3L 2.3L, & 5.0L	250-3421		Loc 13 Wire Harness from Transmission
94 95	Ford	Mustang 3.8L	250-3421		Loc 16 right rear of Engine in a 16 pin connector
94/95	Ford	Mustang 5.0L	250-3421		Loc 16 right rear of Engine in a 16 pin conn
92/93	Ford	Probe 2.2L	250-3084	250-4238	Loc 6 17 pin connector
92	Ford	Probe 3.0L	250-3084		Loc 6 6 pin connector
93	Ford	Probe 2.0L & 2.5L	250-3084	250-4238	Loc 4 60 pin conn or EEC IV Module Pos 3
94	Ford	Probe 2.0L & 2.5L	250-3084	250-4238	Loc 8 Blue 22 pin above Hood Release
95	Ford	Probe	250-3084	250-4238	Behind center console, Pos 3 of 60 pin conn in ECM
92/93/94	Ford & Mercury	Taurus & Sable 3.9L & 3.8L	250-3421		Loc 13 Wire Harness from Transmission
95	Ford & Mercury	Taurus & Sable	250-3421	250-4250	Connector under Air Cleaner Box under hood

\*On All Ford Probes-3 Plug ECU behind Ashtray-Green w/Red Ashtray 22 pin conn. Position 5(4000 ppm)  
Single Plug ECU behind Ashtray - Position 3 Blue w/White (8000ppm)

# FORD & MERCURY

E Vehicle VSS Wire Color	F VSS Pulses	G Cruise Control Blue Wire Attachment For Tach Signal	H Vehicle Tach Wire Color	I Brake Switch Positive	J Brake Switch Negative
Green/Red	4000	Location 16 3 pin conn on distributor	White	Yellow	Green
Yellow/Brown	8000	SPOUT* connector; Center of harness on bulkhead	White/ Purple	Orange/ White	Orange/ Yellow
White/Black or Dk.Green	8000	Loc 14 Black Connector between battery and Shock Tower	Lt. Grn/Yellow Lt.Green/ White	Dk.Green/ Yellow	Dark
Gray or Gray/Black	8000	Location 16 SPOUT*	Pink	Green/ Red	Green
Gray/Black	8000	Position 50 of PCM	Pink	Green/ Red	Green
Gray/Black or Green/White	8000	Location 16 SPOUT*	Pink	Green/ Red	Green
Gray/Black	8000	Loc 16 SPOUT* or in a 12 pin conn at DIS Module	Pink	Green/ Red	Green
Gray/Black	8000	Loc 16 Coil also goes from Coil to 42 pin conn at right rear of Engine	Tan/ Yellow	Green/ Red	Green
Green/Red	4000	Location 16 Distributor	Yellow/ Blue	Green	White
Blue/White	8000	Loc 16 negative side of coil	Yellow/ Blue	Green	White/ Green
Blue/White	8000	Location 16 Coil	Yellow/ Blue	Yellow/ Red	White/ Green
Green/Red	4000	Location 16 Distributor	Yellow/ Blue	Yellow/ Red	White/ Green
Blue/White	8000	Location 16 Coil	Black/ White	Yellow/ Red	White/ Green
Gray/Black or Green/White	8000	Location 16 SPOUT*	Yellow/ Lt. Green	Green/ Red	Green
Dk.Green/ White	8000	SPOUT* connector is found under Air Cleaner Tube coming from back of engine	Pink	Green/ Red	Green

93 2.5 Probe left side of Speedo Cluster - plug that goes into Cluster - Blue/White - 8000 pulse  
\*SPOUT - Gray 2 Pin Connector

# FORD & MERCURY

Vehicle Year	A Vehicle Manufacturer	B Vehicle Model & Engine Size	C Control Switch/ Throttle Adaptor		D Cruise Control Gray Wire Attachment For VSS Signal
92 93/94/95	Ford & Mercury	Tempo & Topaz 2.3L	250-3421 250-3133		Loc 13 Wire Harness from Transmission
92	Ford & Mercury	Thunderbird & Cougar 3.8L	250-3421		Loc 13 Wire Harness from Transmission
95	Ford & Mercury	Thunderbird & Cougar 3.8L	250-3421		Loc 7 Black 12 pin connector Pos 7 or Pos 58 of PCM
95	Ford & Mercury	Thunderbird & Cougar 4.6L	250-3421	250-4241	Loc 7 Black 12 pin connector Pos 7 or Pos 3 of PCM
92/93/94	Mercury	Capri 1.6L	250-3421		Loc 4 13 pin connector
95	Mercury	Villager	250-3421		Pos 32 of Blue 116 pin conn of PCM
92/93/94	Ford Trucks	Aerostar	250-3421		Loc 13 Pos 3 of EEC IV module
95	Ford	Aerostar	250-3421		Loc 7 Black 12 pin connector Pos 7 or Pos 3 of PCM
92/93/94	Ford	Bronco	250-3421		Loc 13 Pos 3 of EEC IV module
95	Ford	Bronco	250-3421		Loc 7 Black 12 pin connector Pos 7 or Pos 3 of PCM
92 93/94/95	Ford	*Econoline	250-3421		Loc 13 Pos 3 from lower right corner of EEC IV module
92 93/94	Ford	Explorer	250-3421		Loc 14 Wire Harness from Transmission
95	Ford	Explorer	250-3421		Wire Harness from Transmission or Pos 3 of PCM in Loc 14
92 93/94	Ford	*F/Pickup	250-3421		Loc 13 Pos 3 of EEC IV module
95	Ford	*F/Pickup	250-3421		Loc 7 Black 12 pin conn Pos 7 Loc 14 Pos 3 of PCM

\*MUST USE ADAPTOR 250-4213 TO READ ROAD SPEED WITH 250-1076

# FORD & MERCURY

E Vehicle VSS Wire Color	F VSS Pulses	G Cruise Control Blue Wire Attachment For Tach Signal	H Vehicle Tach Wire Color	I Brake Switch Positive	J Brake Switch Negative
Gray/Black or Green/White	8000	Location 16 SPOUT*	Yellow/ Lt. Green	Green/ Red	Green
Gray/Black or Green/White	8000	Location 16 SPOUT*	Yellow/ Lt. Green	Green/ Red	Green
Gray/Black or Green/White	8000	Location 16 SPOUT*	Yellow/ Lt. Green or Pink	Green/ Red	Green
Gray/Black or Green/White	8000	Location 16 SPOUT* Location 12 Pos 48 of 104 pin conn	Yellow/ Lt. Grn/Pink Black/White	Orange/ White	Orange/ Blue
Green/Red	4000	Location 16 Coil	Yellow/ Blue	Green/ Yellow	White/ Green
Green/Yellow	4000	Position 2 of PCM	Green/ White	Blue/ White	Blue
Gray/Black	8000	Location 16 SPOUT*	Yellow/ Lt. Green	Lt. Green/ Red	Red/ Lt. Green
Gray/Black	8000	Location 16 Coil	Tan/ Yellow	Green/ Red	Green
Gray/Black	8000	Location 16 Coil SPOUT*	Tan/Yellow Pink	Green/Red	Green
Gray/Black	8000	Location 16 Coil	Tan/ Yellow	Green/ Red	Green
Red/Green or Gray/Black	8000	Location 16 Coil SPOUT*	Tan/Yellow Pink	Green/Red	Green
Gray/Black	8000	Location 16 Coil SPOUT*	Tan/Yellow Pink	Green/Red	Green
Gray/Black	8000	Position 36 of PCM	Pink	Green/ Red	Green
Gray/Black	8000	Location 16 Coil SPOUT*	Tan/Yellow Pink	Green/Red	Green
Gray/Black	8000	Location 16 Coil	Tan/ Yellow	Green/ Red	Green

SPOUT\* - Gray 2 Pin Connector

# FORD & MERCURY

Vehicle Year	A Vehicle Manufacturer	B Vehicle Model & Engine Size	C Control Switch/ Throttle Adaptor		D Cruise Control Gray Wire Attachment For VSS Signal
94/95	Ford	*F/Pickup Diesel	250-3421		Location 7 Black 12 pin conn Pos 7 Pos 7 or Pos 58 of PCM in loc 14
92/93	Ford	Ranger	250-3421		Loc 14 wire harness from transmission
95	Ford	*Windstar 3.8L	250-3421		Loc 13 wire harness from transmission or Loc 6 Gray 22 pin conn position A-14

**FIGURE 5**

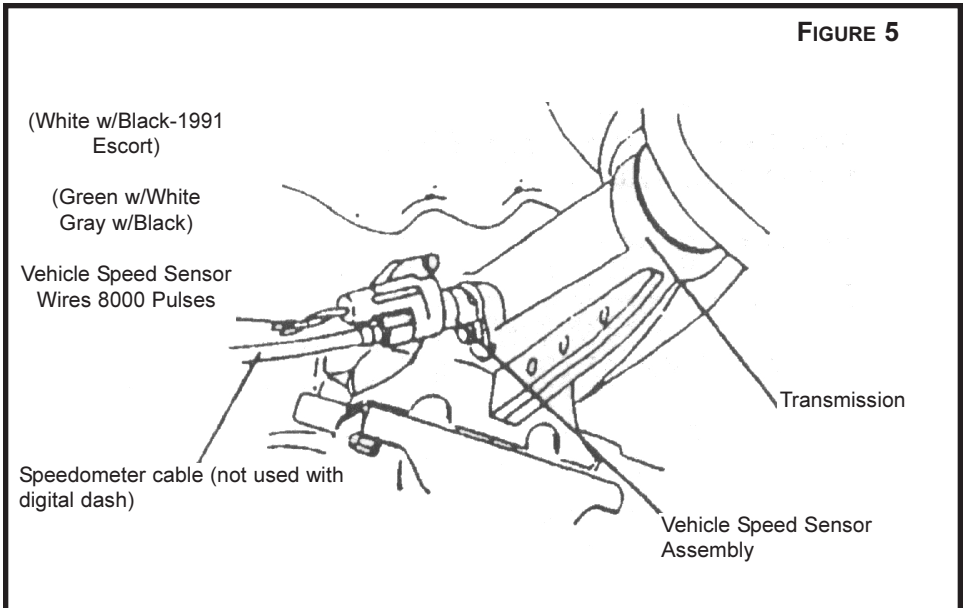

**THUNDERBIRD AND COUGAR**

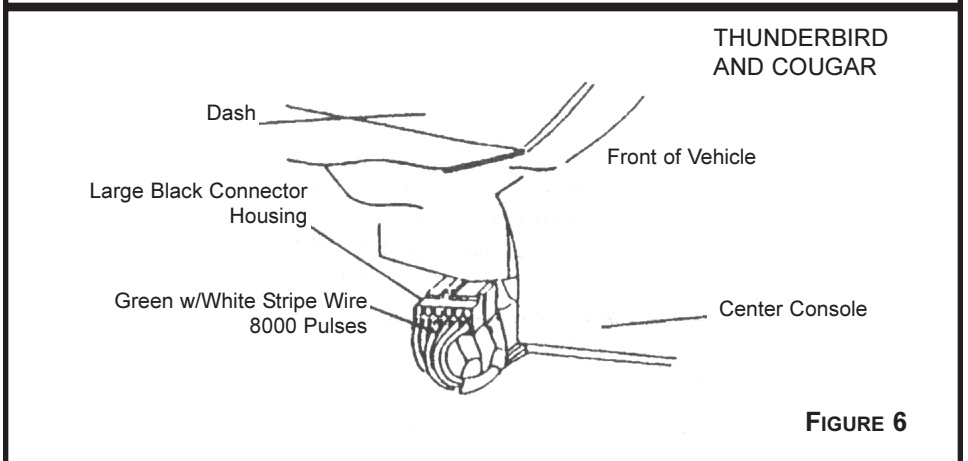

**FIGURE 6**



# FORD & MERCURY

E Vehicle VSS Wire Color	F VSS Pulses	G Cruise Control Blue Wire Attachment For Tach Signal	H Vehicle Tach Wire Color	I Brake Switch Positive	J Brake Switch Negative
Gray/Black	8000	If manual transmission use 250-4206	N/A	Green/ Red	Green
Gray/Black	8000	Location 15 SPOUT*	Pink	Green/ Red	Green
Green/White or Gray/Black	8000	Location 17 SPOUT*	Pink	Green/ Red	Green

## Ford EEC

Shown From Wire Side of Connector  
(not plug side)

Position #3, Gray Black or Red/Green  
8000 PPM\*DSS or VSS

**FIGURE 7**

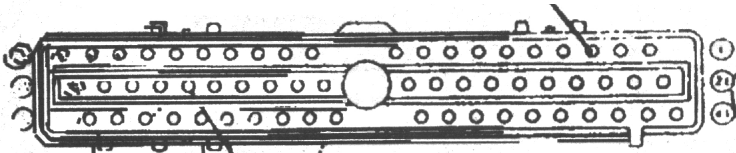

Position #36, Pink Wire  
TACH

\*NOTE: All Ford  
Vehicles with DSS  
(Differential Speed  
Sensor) Must use  
adaptor #250-4213 with  
Microcruise

NOTE: This may be a 17 pin connector housing on some 1990-92 models.

13 Pin Connector Housing (usually Green or White)

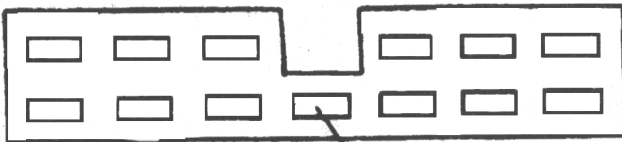

Green w/Red stripe  
(VSS Wire)  
4000 Pulses

**FIGURE 8**

From Trans Gray w/Black Position 3 - VSS ECC IV  
Position 36 TACH - ECC IV - From Spout Connector

# GENERAL MOTORS

Vehicle Year	A Vehicle Manufacturer	B Vehicle Model & Engine Size	C Control Switch/ Throttle Adaptor		D Cruise Control Gray Wire Attachment For VSS Signal
92 93	Buick	Century 2.5L	250-3091 250-3180		Loc 2 White 24 pin conn of ECM Pos W22 Loc 2 Pink 32 pin conn, Pos D-13
94 95	Buick	Century 2.2L	250-3091 250-3180		Loc 2 24 pin Pink conn Pos B-8
92 93	Buick	Century 3.3L	250-3091 250-3180		Loc 2 Black 24 pin conn of ECM pos B11
94 95	Buick	Century 3.1L	250-3091 250-3180		Loc 2 32 pin Green conn Pos D-10
92/93	Buick	LeSabre	250-3175		Loc 1 Green 32 pin conn of PCM, Pos D-10
94/95	Buick	LeSabre	250-3175		Loc 2 32 pin White conn, Pos D-15
95	Buick	Park Avenue	250-3175		Loc 2 Pos D-15 of White 32 pin conn
92/93	Buick	Regal 3.1L	250-3180		Loc 17 White conn Pos B-8
94/95	Buick	Regal 3.1L	250-3180		Loc 11 Black 32 pin conn Pos 28
92	Buick	Regal 3.8L	250-3180		Loc 17 Purple conn Pos P-13
95	Buick	Regal 3.8L	250-3180		Loc 17 Pos B-18 of Clear 32 pin conn
95	Buick	Riviera	250-3180		Loc 12 White 32 pin conn Pos D-15
95	Buick	Roadmaster	250-3180		Loc 15 under air cleaner Black 32 pin conn Pos B-8
92 93/94/95	Buick	Skylark 2.3L	250-3421		Loc 2 Black 24 pin conn Pos B-11 Loc 2 Pink 24 pin conn Pos B-8
92/93	Buick	Skylark 3.3L	250-3421		Loc 2 Black 24 pin conn Pos B-11

# GENERAL MOTORS

E Vehicle VSS Wire Color	F VSS Pulses	G Cruise Control Blue Wire Attachment For Tach Signal	H Vehicle Tach Wire Color	I Brake Switch Positive	J Brake Switch Negative
Brown Any Color	4000	Loc 2 White 24 pin conn of ECM Pos W6 Loc 2 Pink 32 pin conn D-5	White	Orange	White
Dk.Green or Dk.Grn/White	4000	Loc 2 Pink 32 pin conn Pos. B-3	White	Orange	White Yellow
Brown Green/White	4000	Loc 2 Black 32 pin conn of ECM Pos C-8	White	Orange	White
Dk.Green or Dk.Grn/White	4000	Loc 2 Black 32 pin conn, Pos C-7	White	Orange	White Yellow
Dk.Green	4000	Loc 1 Black 32 pin conn, Pos C-7	White	Orange	White
DkGrn/White	4000	Loc 2 Red 32 pin conn, Pos B-16	White	Orange	White
Dk.Grn/White	4000	Loc 2 Pos B-16 of Red 32 pin conn	White	Orange	White
Dk.Green	4000	Loc 17 Green conn, Pos C-9	White	Orange	White
Dk.Green	4000	Loc 16 Pos C of 6 pin conn on Ignition Control Module	White	Orange	White
Dk.Green	4000	Loc 17 Gray conn, Pos G2	White	Orange	White
Dk.Green	4000	Loc 16 Pos E of 14 pin conn on Ignition Control Module	White	Orange	White
Green/White	4000	Loc 12 Red 32 pin conn, Pos B-16	White	Orange	White
Dk.Grn/White	4000	Loc 15 under air cleaner Black 32 pin conn Pos B-5	White	Orange	White
Dk.Green or Dk.Grn/White	4000	Loc 2 Black 32 pin conn, Pos C-8 Loc 2 Pink 24 pin conn, Pos B-3	White	Orange	White
Dk.Green	4000	Loc 2 Black 32 pin conn, Pos C-8	White	Orange	Lt.Blue

# GENERAL MOTORS

Vehicle Year	A Vehicle Manufacturer	B Vehicle Model & Engine Size	C Control Switch/ Throttle Adaptor		D Cruise Control Gray Wire Attachment For VSS Signal
94/95	Buick	Skylark 3.1L	250-3421		Loc 2 Pos 28 of Black 32 pin conn
92	Chevrolet	Camaro 3.1L 5.0L & 5.7L	250-3180 250-3357		Loc 2 Black 24 pin conn, Pos B-11
92	Chevrolet	Camaro 5.0L VINE TBI	250-3180		Loc 2 24 pin conn, Pos A-10
94 95	Chevrolet	Camaro 3.4L	250-3180 250-3357		Loc 11 Black 32 pin conn, Pos 28
94 95	Chevrolet	Camaro 5.7L	250-3180 250-3357		Loc 15 under Air Cleaner Black 32 pin conn, Pos 8
92/93 94/95	Chevrolet	Caprice	250-3126 250-3175		Loc 2 24 pin conn, Pos A-10 Loc 15 Black 32 pin conn, Pos B-8 under Air Cleaner
92/93	Chevrolet	Cavalier 2.2L	250-3446		Loc 1 Pink 32 pin conn, Pos D-13
94	Chevrolet	Cavalier 2.2L	250-3446		Loc 2 Pink 24 pin conn, Pos B-8
95	Chevrolet	Cavalier 2.2L	250-3421		Loc 17 behind Parking Light, access from under vehicle. Pos 8 of Blue 32 pin conn
92/93	Chevrolet	Corsica/ Beretta 2.2L	250-3444		Loc 1 32 pin conn PCM, Pos D-13
94/95	Chevrolet	Corsica/ Beretta 2.2L	250-3444		Loc 2 Pink 24 pin conn, Pos B-8
92/93	Chevrolet	Corsica/ Beretta 3.1L	250-3444		Loc 1 Black 24 pin conn, Pos B-11
94/95	Chevrolet	Corsica/ Beretta 3.1L	250-3444		Loc 2 Black 32 pin conn Pos 28
95	Chevrolet	Impala SS	250-3180		Loc 15 under Air Cleaner Black 32 pin conn, Pos B-8
94	Chevrolet	Lumina Car 2.2L	250-3180		Loc 17 24 pin Brown conn, Pos. D-22

# GENERAL MOTORS

E Vehicle VSS Wire Color	F VSS Pulses	G Cruise Control Blue Wire Attachment For Tach Signal	H Vehicle Tach Wire Color	I Brake Switch Positive	J Brake Switch Negative
Dk.Grn/White	4000	Loc 16 Pos C of 6 pin conn	White	Orange	Lt.Blue
Dk.Green or Gray	4000	Loc 2 Black 32 pin conn C-8	White	Orange	White
Brown	2000	Loc 2 32 pin conn, Pos D-4	White	Orange	White
Dk.Green/ White	4000	Loc 16 6 pin conn of Ignition Module, Position C	White	Orange	White
Green/ White	4000	Loc 15 under Air Cleaner Black 32 pin conn, Pos 5	White	Orange	White
Brown Green/White	2000 4000	Loc 2 32 pin conn, Pos D-4 Loc 15 Black 32 pin conn, Pos B-5 under Air Cleaner	White	Orange	White
Dark Green	4000	Loc 1 Pink 32 conn, Pos D-5	White	Orange	White
Dark Green	4000	Loc 2 Pink 24 pin conn, Pos B-11	White	Orange	White
Dark Green/ White	4000	Loc 17 behind parking light, access from under vehicle Pos 21 of clear 32 pin conn	White	Orange	White
Green/ White	4000	Loc 1 32 pin conn of ECM, Pos. D-5	White	Orange	White
Dk.Green/ White	4000	Loc 2 Pink 24 pin conn, Pos B-11	White	Orange	White
Green/ White	4000	Loc 1 Black 32 pin conn, Pos C-8	White	Orange	White
Dk.Green/ White	4000	Loc 16 Pos C of 6 pin conn on Ignition Control Module	White	Orange	White
Dk.Green/ White	4000	Loc 15 under Air Cleaner Black 32 pin conn, Pos B-5	White	Orange	White
Dk.Green	4000	Loc 17 24 pin Brown conn, Pos D-18	White	Orange	White

# GENERAL MOTORS

Vehicle Year	A Vehicle Manufacturer	B Vehicle Model & Engine Size	C Control Switch/ Throttle Adaptor		D Cruise Control Gray Wire Attachment For VSS Signal
92 93/94	Chevrolet	Lumina Car 2.5L & 3.1L 3.1L & 3.4L	250-3091 250-3180		Loc 17 White conn, Pos B-8
95	Chevrolet	Lumina 3.1L	250-3180		Loc 17 Black 32 pin conn of PCM Pos 28
95	Chevrolet	Lumina 3.4L	250-3180		Loc 17 Red 22 pin conn, Pos 13
95	Chevrolet	MonteCarlo 3.1L	250-3180		Loc 17 Black 32 pin conn of PCM Pos 28
95	Chevrolet	Monte Carlo 3.4L	250-3180		Loc 17 Red 22 pin conn of PCM Pos 13
92/93	Chevrolet & GMC	APV Cargo Van	250-3091		Loc 2 24 pin conn, Pos A-10
92 93/94/95	Chevrolet & GMC Trucks	Astro & Safari	250-3091 250-3108		Loc 2 24 pin conn, Pos A-10 Loc 2 Blue 32 pin conn, Pos D-13
92/93	Chevrolet & GMC Trucks	S-0 & S-15 2.5L & 2.8L	250-3091		Loc 2 24 pin conn, Pos A-10
94	Chevrolet & GMC Trucks	S-10 & S-15 2.2L	250-3091 250-3180		Loc 2 Blue 32 pin conn of PCM Position F-13
95	Chevrolet & GMC Trucks	S-10 & Sanoma 2.2L	250-3421		Loc 2 Blue 32 pin conn of PCM, Pos 13
93	Chevrolet & GMC Trucks	S-10 & S-15 4.3L Man.	250-3091 250-3180		Loc 2 Blue 32 pin conn, Pos D-1
92 93	Chevrolet & GMC Trucks	S-10 & S-15 4.3L	250-3091 250-3180		Location 2 24 pin conn, Pos A-10 Loc 2 Blue 32 pin conn, Pos D-13
94	Chevrolet & GMC Trucks	S-10 & S-15(Man) 4.3L Eng.	250-3091 250-3180		Loc 17 Gray 32 pin conn Pos 8
95	Chevrolet & GMC Trucks	S-10 & S-15 4.3L (Man)	250-3421		Loc 17 Gray 32 pin conn of PCM, Position 8
94 93/94/95	Chevrolet & GMC Trucks	S-10 & S-15 4.3L Eng	250-3091 250-3180		Loc 2 24 pin conn Pos. A-10

# GENERAL MOTORS

E Vehicle VSS Wire Color	F VSS Pulses	G Cruise Control Blue Wire Attachment For Tach Signal	H Vehicle Tach Wire Color	I Brake Switch Positive	J Brake Switch Negative
Dk.Green	4000	Loc 17 Green conn, Pos C-9	White	Orange	White
Dk.Green	4000	Loc 16 between engine and firewall Position C of 6 pin connector	White	Orange	White
Dk.Green	4000	Loc 16 Pos C of 6 pin conn on Ignition Control Module	White	Orange	White
Dk.Green	4000	Loc 16 Between engine and firewall Pos. C of 6 pin conn	White	Orange	White
Dk.Green	4000	Loc 16 between engine and firewall Pos. C of 6 pin conn	White	Orange	White
Brown	2000	Loc 2 32 pin conn, Pos. D-4	White	Orange	White
Brown Dk.Blue	2000	Loc 2 32 pin conn, Pos D-4 Loc 2 32 pin Blue conn, Pos D-11	White	Orange	White
Brown or Red	2000 4000	Loc 2 32 pin conn, Pos D-4 Pos 9 Loc 16 Coil	White	Orange	White
Brown	2000	Loc 2 Blue 32 pin conn, PCM Pos F-11	White	Orange	White
Red or Brown	2000	Loc 2 Blue 32 pin conn of PCM Position 11	White	Orange	White
Yellow	4000	Loc 2 Red 32 pin conn PCM Pos B-4	White	Orange	White
Brown Usually Brown	2000	Loc 2 32 pin conn, Pos D-4 Loc 2 32 pin Blue conn, Pos D-11	White	Orange	White
Yellow	4000	Loc 17 Red 32 pin conn, Pos 18 Negative side of Brake Relay	White	Orange	White
Green/White	4000	Loc 17 Red 32 pin conn of PCM Position 18	White	Orange	White
Brown	2000	Loc 2 32 pin conn, Pos. D-4	White	Orange	White

# GENERAL MOTORS

Vehicle Year	A Vehicle Manufacturer	B Vehicle Model & Engine Size	C Control Switch/ Throttle Adaptor		D Cruise Control Gray Wire Attachment For VSS Signal
94	Chevrolet & GMC Trucks	S-10 & S-15 (Auto) 4.3L	250-3091 250-3180		Loc 2 Blue 32 pin conn of PCM Position 13
95	Chevrolet & GMC Trucks	S-10 & S-15 (Auto) 4.3L	250-3421		Loc 2 Blue 32 pin conn of PCM, Position 13
95	Chevrolet & GMC Trucks	S-10 & S-15 4.3L Vortec	250-3421		Loc 17 Pos 3 of Black 24 pin conn
92 93/94/95	Chevrolet & GMC Trucks	Blazer & Jimmy 4.3L	250-3091 250-3180		Loc 2 24 pin conn, Pos A-10 Loc 2 32 pin Blue conn, Pos 13-D
92 93/94	Chevrolet & GMC Trucks	V-Blazer & V-Jimmy	250-3091 250-3180		Loc 8 upper left of convenience center, center spade (ORN)
95	Chevrolet & GMC Trucks	V-Blazer & V-Jimmy	250-3421		Loc 2 below glove box. Digital Ratio Adaptor below ECM. Attach to VSS wire in 9 pin conn
92/93 94/95	Chevrolet & GMC Trucks	Lumina APV 3.1L	250-3091 250-3180		Loc 2 24 pin conn, Pos A-10
92 93	Chevrolet & GMC Trucks	Lumina APV 3.8L	250-3091 250-3180		Loc 2 Green 32 pin conn of PCM Position D-7
95	Chevrolet	Lumina APV 3.8L	250-3091 250-3180		Loc 2 White 32 pin conn. Pos D-15
92 93/94	Chevrolet & GMC Trucks	C/K Pickups	250-3091 250-3180		Loc 8 upper left to convenience center, spade (ORN)
95	Chevrolet & GMC Trucks	C/K Pickups	250-3421		Loc 2 below glove box. Digital Ratio Adaptor is just under ECM. Attach to VSS wire in 9 pin conn
94	Chevrolet & GMC Trucks	#C/K Pickups 6.5L Diesel Turbo/Non Turbo	250-3091 250-3180		X Loc 2 Pos D-8 of Lt. Blue 32 pin conn
95	Chevrolet & GMC Trucks	#C/K Pickups 6.5L Diesel	250-3421		Loc 2 below glove box. Digital Ratio Adaptor is under ECM. Attach to VSS wire in 9 pin conn
92	Chevrolet & GMC Trucks	Suburban 5.7L	250-3091 250-3180		*Loc 8 upper left of convenience center, center spade (ORN)
95	Chevrolet & GMC Trucks	Suburban 5.0L & 5.7L	250-3421		Loc 2 Pos A-10 of 24 pin conn of ECM



# GENERAL MOTORS

E Vehicle VSS Wire Color	F VSS Pulses	G Cruise Control Blue Wire Attachment For Tach Signal	H Vehicle Tach Wire Color	I Brake Switch Positive	J Brake Switch Negative
Brown	2000	Loc 2 Blue 32 pin conn of ECM Pos F-11	White	Orange	White
Red	2000	Loc 2 Blue 32 pin conn of PCM, Position 11	White	Orange	White
Green/White	4000	Loc 17 Pos 9 of White or Clear 32 pin conn	White	Orange	White
Brown or Red	2000	Loc 2 32 pin conn, Pos D-4 Loc 2 32 pin Blue conn, Pos D-11	White	Orange	White
N/A	4000	Loc 16 Ignition Coil	Brown or White	Orange	White
Green/White	4000	Location 16 Ignition Coil	White or Brown	Orange	White
Brown or Red	2000	Loc 2 32 pin conn, Pos D-4	White	Orange	White
Dk.Green	4000	Loc 2 Black 32 pin conn of PCM, Position C-7	White	Orange	White
Dk.Green	4000	Loc 16 Pos E of 14 pin conn on Ignition Control Module	White	Orange	White
N/A	4000	Loc 16 Ignition Coil	Brown or White	Orange	White
Green/White	4000	Loc 16 Coil	White	Orange	White
Brown/White Green/White	2000	If manual transmission, use 250-4206	N/A	Orange	White
Green/White	4000	If manual transmission, use 250-4206	N/A	Orange	White
N/A	4000	Loc 16 Ignition Coil	White	Orange	White
Dk.Blue	2000	Pos D-4 of 32 pin conn of ECM	White	Orange	White

# GENERAL MOTORS

Vehicle Year	A Vehicle Manufacturer	B Vehicle Model & Engine Size	C Control Switch/ Throttle Adaptor		D Cruise Control Gray Wire Attachment For VSS Signal
92 93/94 95	Chevrolet & GMC Trucks	G-Van	250-3091 250-3180		*Loc 10 24 pin conn of ECM, Pos A-10 X Loc 10 32 pin Blue conn of PCM D-13 or F-13 if E/F connector
94/95	Chevrolet & GMC Trucks	#G-Van 6.5L Diesel Turbo/ Non Turbo	250-3091 250-3180		X Loc 10 Pos D-8 of Lt. Blue 32 pin conn
92 93/94	Geo	*Metro	250-3421		Loc 8 connector above fuse panel
95	Geo	*Metro	250-3421		Loc 2 Center of three connectors in ECM
92	Geo	Prizm	250-3421	250-4199	Loc 5 right connector of ECM (89-92)
93/94 95	Geo	Prizm	250-3421 250-4219		3 pin conn on transaxle behind engine or under coin tray black connector 2nd from corner
92 93	Geo	*Storm SOHC	250-3421		Loc 8 Black independent connector or 24 pin conn of ECM, Pos A-10
92 93/94	Geo	*Tracker	250-3421		Loc 8 Yellow conn of ECM, Pos Y-15
95	Geo	*Tracker 1.6L (Vin 6)	250-3421		Loc 7 Yellow 22 pin conn, Pos 7
95	Geo	*Tracker 1.6L (Vin U)	250-3421		Loc 7 Yellow 24 pin conn, Pos 15
92 93	Oldsmobile	Achieva 2.3L	250-3421		Loc 2 Black 24 pin conn, Pos. B-11 Loc 2 Pink 24 pin conn, B-8
94/95	Oldsmobile	Achieva 2.3L	250-3421		Loc 2 Pink 24 pin conn, Pos B-8
92/93	Oldsmobile	Achieva 3.3L	250-3421		Loc 2 Black 24 pin conn, Pos. B-11
94/95	Oldsmobile	Achieva 3.1L	250-3421		Loc 2 Black 32 pin conn Pos 28
95	Oldsmobile	Aurora			Loc 12 White 32 pin conn, Pos D-15

\*RECOMMENDED PEDAL PULL FOR SAFETY REASONS

# GENERAL MOTORS

E Vehicle VSS Wire Color	F VSS Pulses	G Cruise Control Blue Wire Attachment For Tach Signal	H Vehicle Tach Wire Color	I Brake Switch Positive	J Brake Switch Negative
Brown Dk.Blue or Green/White	2000	Loc 16 Ignition Coil X Loc 10 32 pin Blue conn D-11	White	Orange	White
Brown/White Green/White	2000	N/A	N/A	Orange	White
Yellow/Green	4000	Loc 16 Ignition Coil	Brown	White	Green
Yellow/Green	4000	Loc 16 Coil	Brown	White	Green
Violet/White	4000	Loc 16 Ignition Coil	Black	White	Green
Red/Yellow	4000	Loc 16 2 pin at Distributor	Black	Green/ Red	Green/ White
White/Rust or Silver Dots or White	4000	Loc 16 Coil or Loc 8 32 pin conn, Pos D-4	Brown Yellow	Green	Green/ Yellow
Yellow Yellow/ Brown Dots	4000	Loc 16 Ignition Coil	Brown/White Black/Green	Green	Green/ White
Yellow	4000	Loc 7 Yellow 22 pin conn Pos 8	Brown	Green	Green/ White
Yellow	4000	Loc 7 Yellow 24 pin conn Pos 1	Brown	Green	Green/ White
Dk.Green	4000	Loc 2 Black 32 pin conn, Pos C-8 Loc Pink 24 pin conn, B-3	White	Orange	Lt.Blue
Dk.Green	4000	Loc 2 Pink 24 pin conn, Pos B-11	White	Orange	White
Dk.Green	4000	Loc 2 Black 32 pin conn, Pos C-8	White	Orange	White
Dk.Green/ White	4000	Loc 16 Pos C of 6 pin conn on Ignition Control Module	White	Orange	Lt.Blue
Green/White	4000	Loc 12 Red 32 pin conn, Pos B-16	White	Orange	White

# GENERAL MOTORS

Vehicle Year	A Vehicle Manufacturer	B Vehicle Model & Engine Size	C Control Switch/ Throttle Adaptor		D Cruise Control Gray Wire Attachment For VSS Signal
92 93	Oldsmobile	Ciera 2.5L	250-3091 250-3180		Loc 2 24 pin conn of ECM, Pos. W-22 Loc 2 Pink 32 pin conn D-13
94/95	Oldsmobile	Ciera 2.2L	250-3180		Loc 2 Pink 24 pin conn, Pos. B-8
92	Oldsmobile	Ciera 3.3L	250-3180		Loc 2 Black 24 pin conn, Pos. B-11
94/95	Oldsmobile	Ciera 3.1L	250-3091		Loc 2 Green 32 pin conn Pos. D-10
93/94 95	Oldsmobile	Supreme 3.1 Calif.Only	250-3091 250-3180		Loc 17 Black conn 32 pin, B-28
92 93	Oldsmobile	Supreme 3.1L 3.4L except Calif	250-3180		Loc 17 White conn, Pos B-8
95	Oldsmobile	Cutlass Supreme 3.1L	250-3180		Loc 17 Black 32 pin conn Pos 28
95	Oldsmobile	Cutlass Supreme 3.4L	250-3180		Loc 17 Red 32 pin conn Pos B-13
92 93	Oldsmobile	Delta 88	250-3175		Loc 2 Green 32 pin conn of PCM Position D-10
94 95	Oldsmobile	Delta 88	250-3175		Loc 2 White 32 pin conn Pos. D-15
92 93	Oldsmobile	Silhouette 3.8L	250-3167		Loc 2 Green 32 pin conn of PCM, Position D-7
95	Oldsmobile	Silhouette 3.8L	250-3167		Loc 2 White 32 pin conn of PCM, Position D-15
92 93	Pontiac	Bonneville	250-3175		Loc 2 Green 32 pin conn of PCM, Position D-10
94/95	Pontiac	Bonneville	250-3175		Loc 2 White 32 pin conn Pos D-15
92	Pontiac	Firebird	250-3180 250-3357		Loc 2 Black 24 pin conn, Pos B-11

\*RECOMMENDED PEDAL PULL FOR SAFETY REASONS

# GENERAL MOTORS

E Vehicle VSS Wire Color	F VSS Pulses	G Cruise Control Blue Wire Attachment For Tach Signal	H Vehicle Tach Wire Color	I Brake Switch Positive	J Brake Switch Negative
Brown Any Color	4000	Loc 2 Black 24 pin conn of ECM PosW6 Loc 2 Pink 32 pin conn D-5	White Any Color	Orange	White
Dk.Green	4000	Loc 2 Pink 24 pin conn Pos B-3	White	Orange	White
Brown Dk.Green/ White	4000	Loc 2 Black 32 pin conn, Pos C-8	White	Orange	White
Dk.Green	4000	Loc 2 Black 32 pin conn Pos C-7	White	Orange	White
Dk.Green	4000	Loc 17 Blue 32 pin conn C-27	White	Orange	White
Dk.Green	4000	Loc 17 Green conn, Pos C-9	White	Orange	White
Dk.Green	4000	Loc 16 Pos C of 6 pin conn on Ignition Control Module	White	Orange	White
Dk.Green	4000	Loc 16 Pos C of 6 pin conn on Ignition Control Module	White	Orange	White
Dk.Green	4000	Loc 2 Black 32 pin conn of PCM Position C-7	White	Orange	White
Green/White	4000	Loc 2 Red 32 pin conn Pos B-16	White	Orange	White
Dk.Green	4000	Loc 2 Black 32 pin conn of PCM Position C-7	White	Orange	White
Dk.Green	4000	Loc 2 Pos E of 14 pin conn on Ignition Control Module	White	Orange	White
Dk.Green	4000	Loc 2 Black 32 pin conn, Pos C-7	White	Orange	White
Green/White	4000	Loc 2 Red 32 pin conn, Pos B-16	White	Orange	White
Dk.Green or Gray	4000	Loc 2 Black 32 pin conn, Pos C-8	White	Orange	White

# GENERAL MOTORS

Vehicle Year	A Vehicle Manufacturer	B Vehicle Model & Engine Size	C Control Switch/ Throttle Adaptor		D Cruise Control Gray Wire Attachment For VSS Signal
92	Pontiac	Firebird 5.0L TBI	250-3180		Loc 2 24 pin conn Pos. A-10
94/95	Pontiac	Firebird 3.4L	250-3175 250-3357		Loc 11 32 pin black conn, Pos 28
94/95	Pontiac	Firebird 5.7L	250-3175 250-3357		ECM under hood. Pos B-8 of Black 32 pin connector
92 93/94/95	Pontiac	GrandAm	250-3421		Loc 2 Black 24 pin conn, Pos.B-11 Loc 2 Pink 24 pin conn, Pos B-8
92/93	Pontiac	GrandAM 3.3L	250-3421		Loc 2 Black 24 pin conn, Pos B-11
94/95	Pontiac	GrandAm 3.1L	250-3421		Loc 2 Black 32 pin conn, Pos 28
92/93	Pontiac	Grand Prix 3.1L	250-3167		Loc 17 White conn, Pos B-8
94/95	Pontiac	Grand Prix 3.1L	250-3175		Loc 17 Gray 32 pin conn, Pos 28
95	Pontiac	Grand Prix	250-3180		Loc 17 Red 22 pin conn Pos B-13
92/93 94	Pontiac	Lemans	250-3421		Must use magnet - 250-4165
92/93/94	Pontiac	Sunbird 2.0L	250-3167		Loc 2 32 pin conn, Pos C-4
92/93	Pontiac	Sunbird 3.1L	250-3167		loc 2 Black 24 pin conn, Pos B-11
95	Pontiac	Sunfire 2.2L	250-3421		Loc 17 Blue 32 pin conn Pos 8
95	Pontiac	Sunfire 2.3L	250-3421		Loc 17 Blue 32 pin conn Pos 8
92/93 94/95	Pontiac	Transport 3.1L	250-3167		Loc 2 24 pin conn Pos A-10
92 93	Pontiac	Transport 3.8L	250-3167		Location 2 Green 32 pin conn at PCM Position D-7

# GENERAL MOTORS

E Vehicle VSS Wire Color	F VSS Pulses	G Cruise Control Blue Wire Attachment For Tach Signal	H Vehicle Tach Wire Color	I Brake Switch Positive	J Brake Switch Negative
Brown	2000	Loc 2 32 pin conn, Pos D-4	White	Orange	White
Dk.Green/ White	4000	Loc 16 6 pin conn of ignition module, Position C	White	Orange	White
Green/ White	4000	ECM under hood. Pos B-5 of Black 32 pin connector	White	Orange	White
Dk.Green Green/White	4000	Loc 2 Black 32 pin conn, Pos C-8 Loc 2 Pink 24 pin conn, Pos B-3	White	Orange	White
Dk.Green	4000	Loc 2 Black 32 pin conn, Pos C-8	White	Orange	White
Dk.Green Green/White	4000	Loc 2 White 32 pin conn, Pos 19	White	Orange	White
Dk.Green	4000	Loc 17 Gray conn, Pos C-9	White	Orange	White
Dk.Green	4000	Loc 16 6 pin conn of Ignition Module, Position C	White	Orange	White
Dk.Green	4000	Loc 17 Pos C of 6 pin conn on Ignition Control Module	White	Orange	White
N/A	5000	Loc 16 negative coil	Black	White/ Black	Green
Dk.Green	4000	Loc 2 32 pin conn, Pos C-1	White White	Orange	White
Dk.Green	4000	Loc 2 32 pin conn, Pos C-8	White	Orange	White
Dk.Green/ White	4000	Loc 17 Clear 32 pin conn Pos 20 or 32	White	Orange	White
Dk.Green/ White	4000	Loc 17 Blue 32 pin conn, Pos 20	White	Orange	White
Brown Red	2000	Loc 2 32 pin conn, Pos D-4	White	Orange	White
Dk.Green	4000	Loc 2 Black 32 pin conn at PCM Position C-7	White	Orange	White

# GENERAL MOTORS

Vehicle Year	A Vehicle Manufacturer	B Vehicle Model & Engine Size	C Control Switch/ Throttle Adaptor	D Cruise Control Gray Wire Attachment For VSS Signal
95	Pontiac	Transport 3.8L	250-3180	Loc 2 White 32 pin conn Pos D-15
92 93/94	*Saturn	Saturn 1.9L 8 & 16 valve	250-3421	Loc 8 Pos. "T" of independent connector below PCM
95	*Saturn	Saturn	250-3421	Loc 6 Black conn taped to main harness above gas pedal

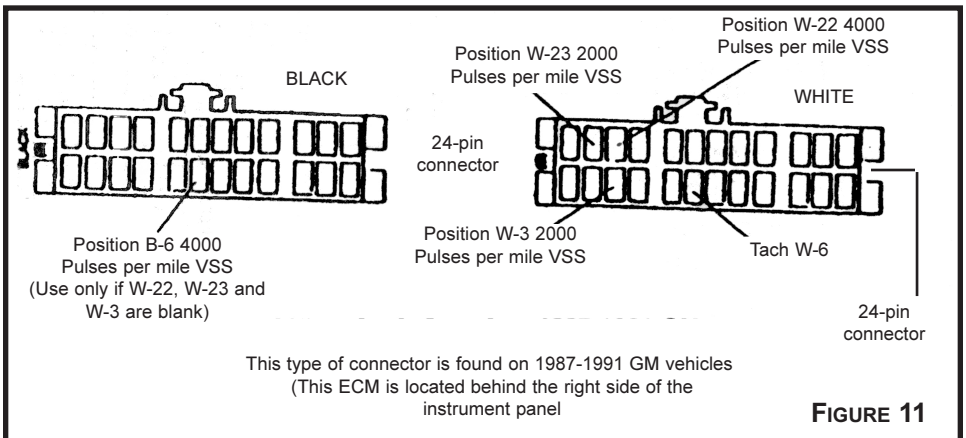
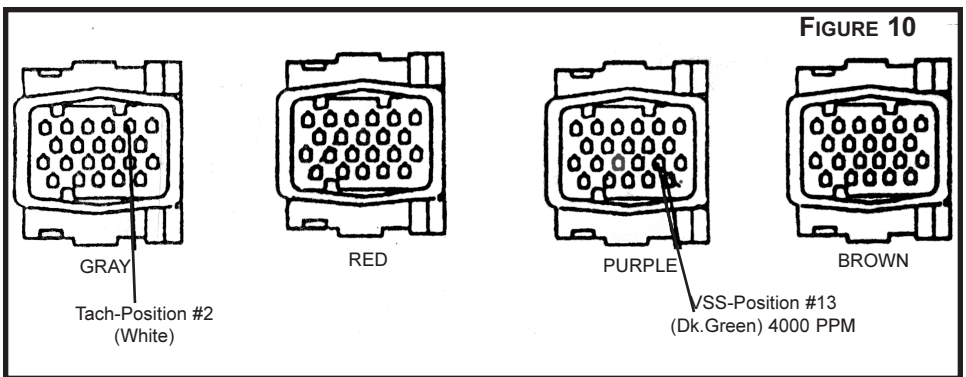
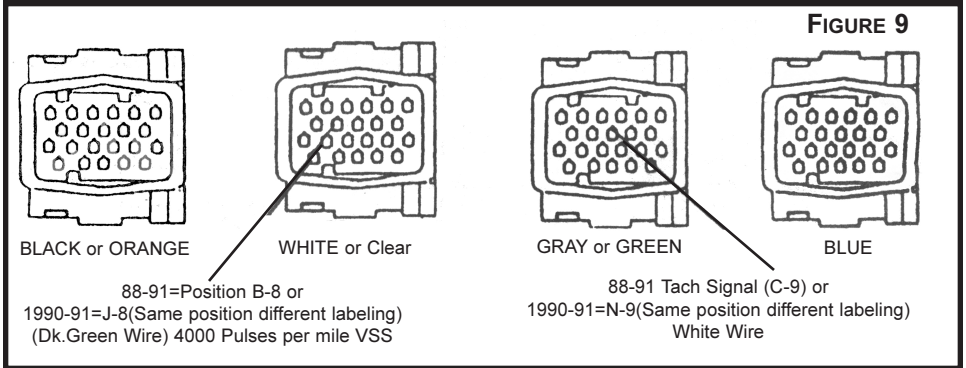



# GENERAL MOTORS

E Vehicle VSS Wire Color	F VSS Pulses	G Cruise Control Blue Wire Attachment For Tach Signal	H Vehicle Tach Wire Color	I Brake Switch Positive	J Brake Switch Negative
Dk.Green	4000	Loc 16 Pos E of 14 pin conn on Ignition Control Module	White	Orange	White
Dk.Green w/White	5000	Loc 8 Pos C-11 of Black 32 pin conn in PCM	White	Orange	White
Dk.Green	5000	Loc 8 Pos C-11 of Black 32 pin conn in PCM	White	Orange	White or Lt. Blue

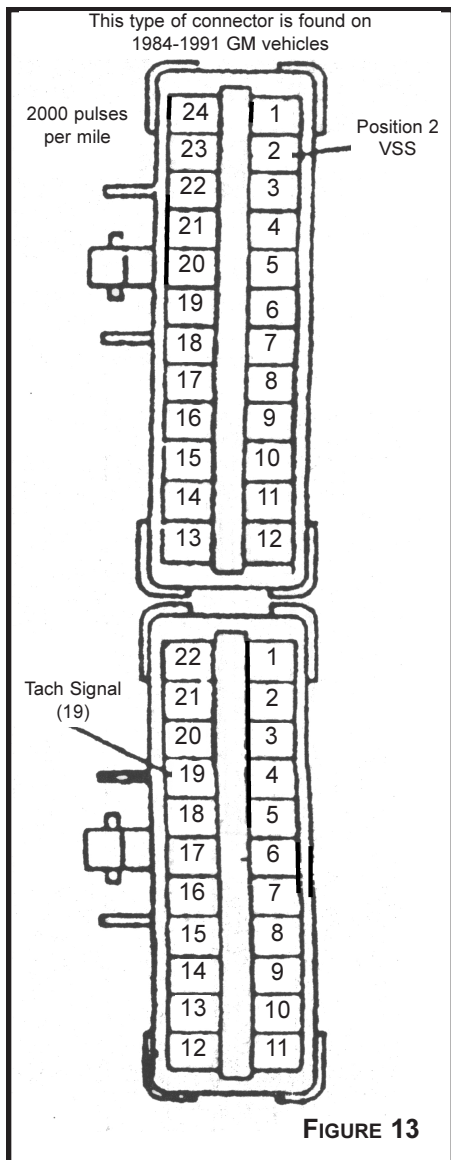
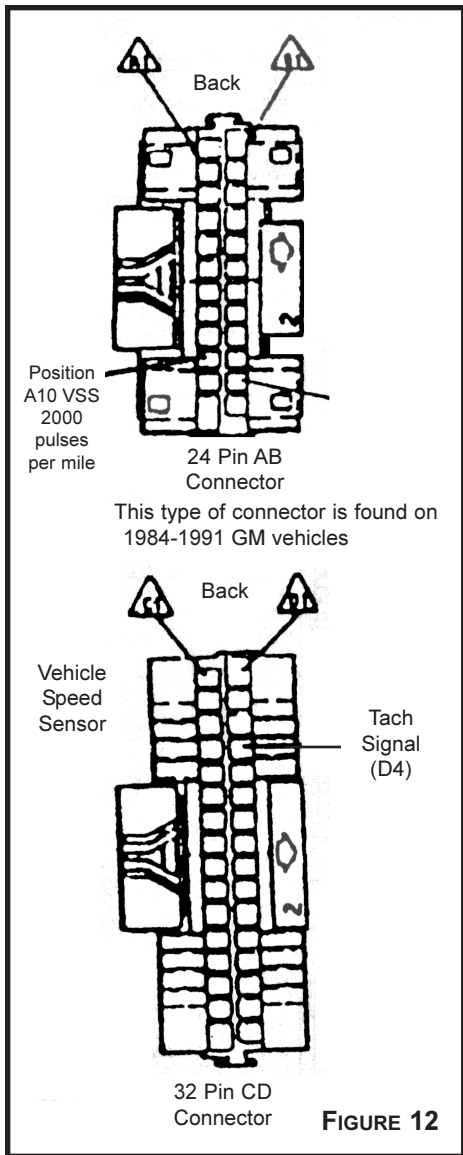

# GENERAL MOTORS

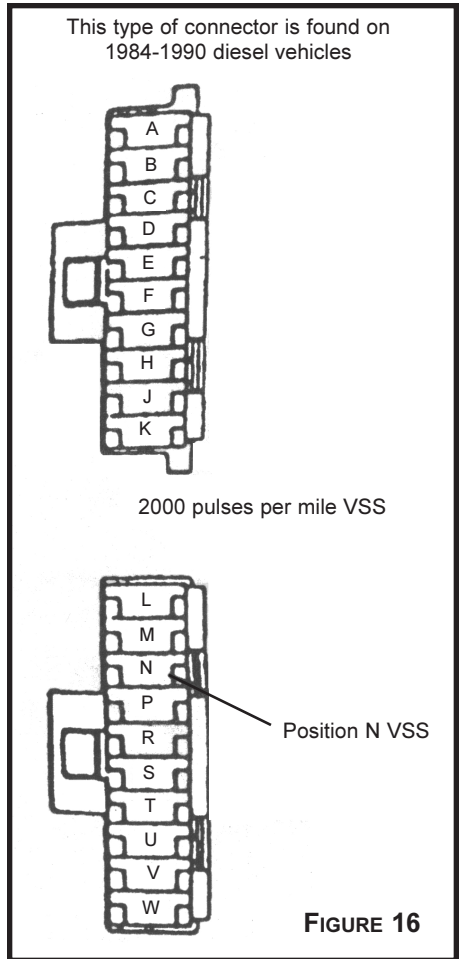
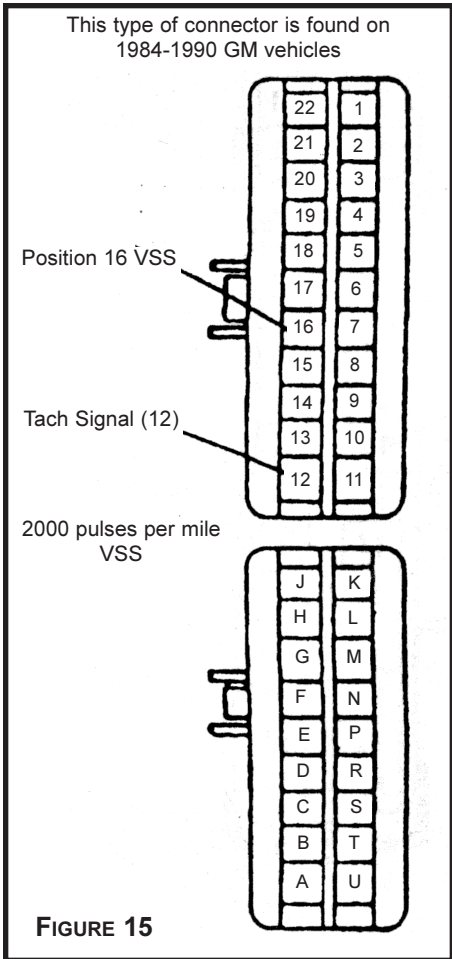
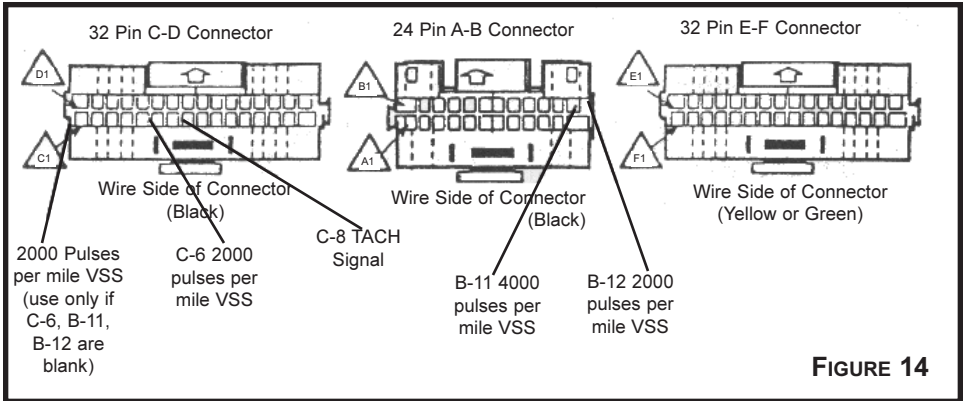

# GENERAL MOTORS

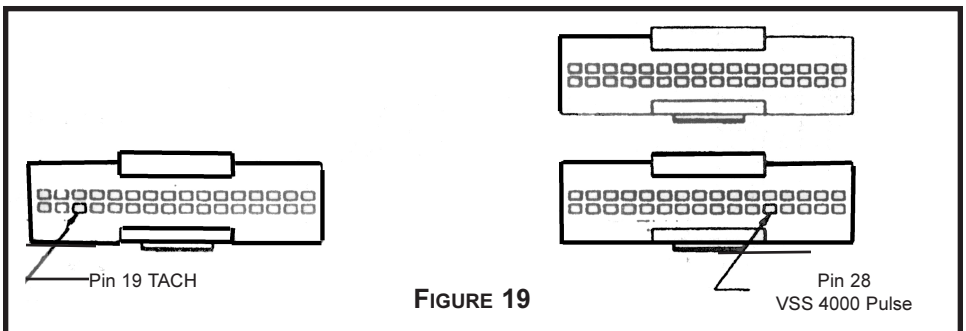
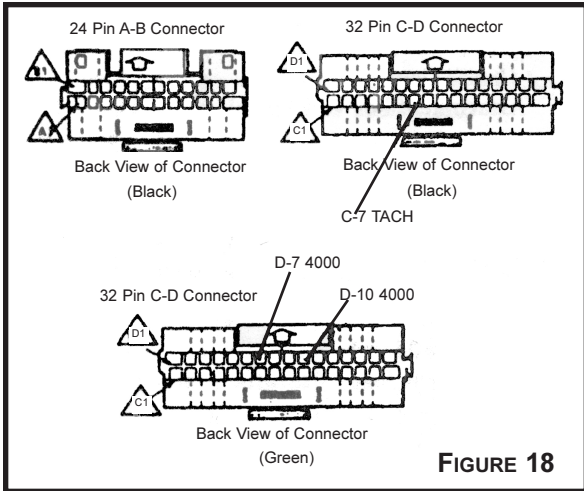
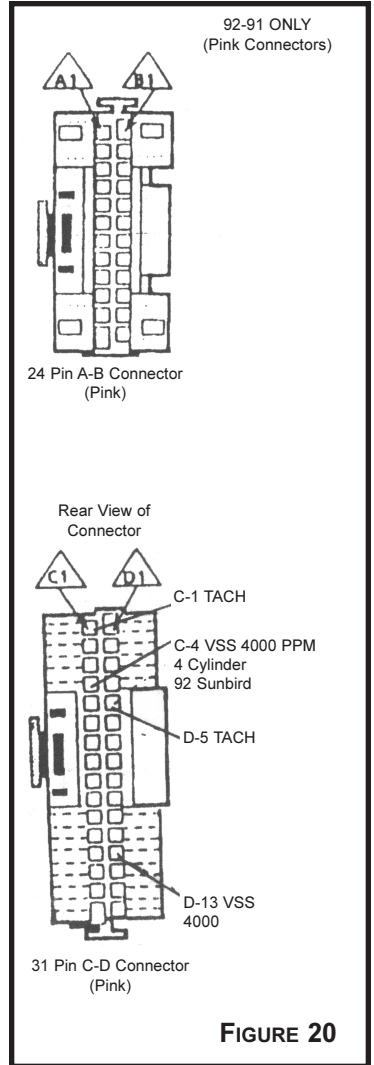
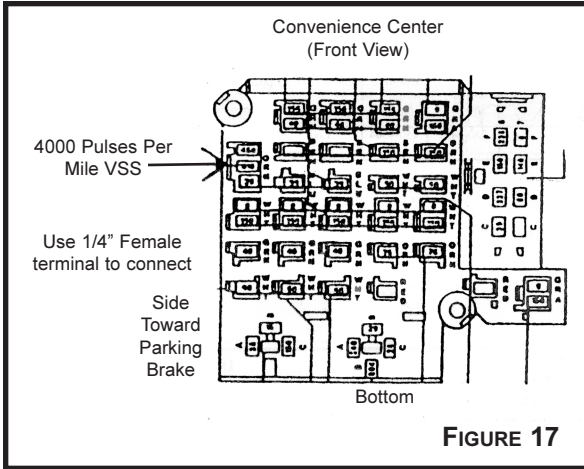

## HONDA

Vehicle Year	A Vehicle Manufacturer	B Vehicle Model & Engine Size	C Control Switch/ Throttle Adaptor		D Cruise Control Gray Wire Attachment For VSS Signal
93	Acura	Integra Pedal Pull Only	250-3421	250-4225	Location 8 24 pin ECM connector above fuse box position 15
94/95	Acura	Integra	250-3421	250-4225	Location 14 connector on shock tower
92/93 94/95	Honda	Civic	250-3421	250-4304	Location 1 16 pin connector at ECM

## HYUNDAI

Vehicle Year	A Vehicle Manufacturer	B Vehicle Model & Engine Size	C Control Switch/ Throttle Adaptor		D Cruise Control Gray Wire Attachment For VSS Signal
95	Hyundai	Accent	250-3421		Location 7 White 22 pin Diagnostic Conn
92 93/94	Hyundai	*Elantra	250-3421		Position 10 of largest conn of ECM 22 pin connector in ECM
95	Hyundai	Elantra	250-3421		Location 8 in 18 pin conn of ECM
94	Hyundai	Excel	250-3421		Location 8 Data Link connector below fuse panel
92 93/94	Hyundai	*Scoupe	250-3421		Largest connector in ECM Single plug ECM Position 9 Location 8
92 93/94	Hyundai	*Sonata 2.4 & 3.0L	250-3421		Largest connector in ECM 22 pin connector in ECM
95	Hyundai	Sonata	250-3421		Location 8 Data Link connector below fuse panel

## KIA

Vehicle Year	A Vehicle Manufacturer	B Vehicle Model & Engine Size	C Control Switch/ Throttle Adaptor		D Cruise Control Gray Wire Attachment For VSS Signal
95	Kia	Sephia	250-3421		Location 4 22 pin conn. of ECM 5th pos. left to right on top row

\*Vehicles sold by Hyundai, built by Mitsubishi, with an automatic transmission are to be pedal pull.  
NOTE: Pre 92 Applications same as Mitsubishi.

# HONDA

<b>E</b> Vehicle VSS Wire Color	<b>F</b> VSS Pulses	<b>G</b> Cruise Control Blue Wire Attachment For Tach Signal	<b>H</b> Vehicle Tach Wire Color	<b>I</b> Brake Switch Positive	<b>J</b> Brake Switch Negative
Yellow/White	4000	Location 16 Negative side of coil	Yellow/ Blue	Green/ Red	Green
Orange	4000	Location 16 Distributor	Yellow/ Blue	Green/ Red	Green
Yellow/Blue	4000	Location 16 Negative side of coil	Yellow/ Blue/ Black	Green/ Red	Green

# HYUNDAI

<b>E</b> Vehicle VSS Wire Color	<b>F</b> VSS Pulses	<b>G</b> Cruise Control Blue Wire Attachment For Tach Signal	<b>H</b> Vehicle Tach Wire Color	<b>I</b> Brake Switch Positive	<b>J</b> Brake Switch Negative
Yellow/White Green/White	4000	Location 16 pin conn below fuel rail	White	Red/ Blue	Green/ Yellow
Yellow/White	4000	Location 16 Left side, 4 wire plug	Green/ White	Red/ Blue	Green/ Yellow
Yellow/White	4000	18 pin conn of ECM	White	Red/ Blue	Green/ Yellow
Yellow/White	4000	Location 16 first conn below fuel rail	White	Red/ Blue	Green/ Yellow
Yellow/White Green/White	4000	Location 18 Distributor	White/ Black	Red/ Blue	Green/ Yellow
Yellow/White	4000			Red/ Blue	Green/ Yellow
Yellow/White	4000	Location 16 first conn below fuel rail	White	Red/ Blue	Green/ Yellow

# KIA

<b>E</b> Vehicle VSS Wire Color	<b>F</b> VSS Pulses	<b>G</b> Cruise Control Blue Wire Attachment For Tach Signal	<b>H</b> Vehicle Tach Wire Color	<b>I</b> Brake Switch Positive	<b>J</b> Brake Switch Negative
Green/Red	4000	Location 16 Connector on distributor	Green	Black/ Orange	Green/ Black

# ISUZU

Vehicle Year	A Vehicle Manufacturer	B Vehicle Model & Engine Size	C Control Switch/ Throttle Adaptor		D Cruise Control Gray Wire Attachment For VSS Signal
92	Isuzu	*Amigo	250-3421		Pos A-10 of 24 pin conn in ECM or Pos 9 of 14 pin conn in ECM
93 94	Isuzu	*Amigo 2.6L	250-3421		Loc 8 22 pin conn Position 5
92 93	Isuzu	*Impulse 1.6L & 1.8L	250-3421		Pos A-10 of 24 pin conn in ECM
92 93/94	Isuzu	*Pickup 2.3L	250-3421		Loc 8 pos 14 of 17 pin conn
92	Isuzu	*Pickup 2.6L	250-3421		Pos 9 of 14 pin conn in ECM
93 94	Isuzu	*Pickup 2.6L	250-3421		Loc 8 22 pin conn, Pos 5
92	Isuzu	Pickup 3.1L	250-3421		Pos A-10 24 pin conn in ECM
92/93/94	Isuzu	*Rodeo 2.3L	250-3421		Loc 8 Pos 14 of 17 pin conn
92	Isuzu	*Rodeo 2.6L	250-3421		Pos A-10 of 24 pin conn in ECM
93/94	Isuzu	*Rodeo 2.6L	250-3421		Loc 8 ECM 22 pin plug Pos 5
95	Isuzu	*Rodeo 2.6L	250-3421		Loc 5 22 pin conn of ECM behind center console, Pos 5
92 93	Isuzu	Rodeo 3.1L	250-3421		Pos A-10 of 24 pin conn in ECM
93 94	Isuzu	*Rodeo 3.2L	250-3421		Loc 8 pin conn above kick panel
92/93	Isuzu	*Stylus	250-3421		Pos A-10 of 24 pin conn in ECM
92	Isuzu	Trooper 2.6L	250-3421	250-4205	Loc 7 above hood release (89-94)

\*RECOMMENDED PEDAL PULL

# ISUZU

E Vehicle VSS Wire Color	F VSS Pulses	G Cruise Control Blue Wire Attachment For Tach Signal	H Vehicle Tach Wire Color	I Brake Switch Positive	J Brake Switch Negative
Yellow/Green or Yellow	2000 4000	Position D-4 of 32 pin conn in ECM or Position 1 of 10 pin conn in ECM	White/Red or Blue	Green	Red
White/Green	4000	Loc 8 22 pin conn, Pos 1	Blue	Green	Red
White	2000	Pos D-4 of 32 pin conn in ECM	Yellow	Green	Green/ Yellow
White/Green	4000	Location 16 Coil	Blue	Green	Green/ Red
Yellow	4000	Pos 1 of 10 pin conn in ECM	Blue	Green	Red
White/Green	4000	Loc 8 22 pin conn, Pos 1	Blue	Green	Red
Yellow/Green	2000	Pos D-4 of 32 pin conn in ECM	White/ Red	Green	Red
White/Green	4000	Location 16 Coil	Blue	Green	Green/ Red
Yellow/Green	2000	Pos D-4 of 32 pin conn in ECM	White/ Red	Green	Red
White/Green	4000	Loc 8 ECM 22 pin conn, Pos 1	Blue		
White	4000	Loc 5 22 pin conn behind center console, Position 1	Yellow	Green	Red
Yellow/Green	2000	Pos D-4 of 32 pin conn in ECM	White/ Red	Green	Red
Lt.Green/ Silver Dots	4000	Loc 16 Coil Pack 2nd Pos in Largest Connector	Yellow	Green	Red
White	2000	Pos D-4 of 32 pin conn in ECM	Yellow	Green	Green/ Yellow
Lt.Green/ Yellow	4000	Location 16 bottom of Coil	Blue	Green	Green/ Red

# ISUZU

Vehicle Year	A Vehicle Manufacturer	B Vehicle Model & Engine Size	C Control Switch/ Throttle Adaptor		D Cruise Control Gray Wire Attachment For VSS Signal
92	Isuzu	Trooper 2.8L	250-3421		Location 7 Above Hood Release
92 93/94	Isuzu	*Trooper 3.2L	250-3421		Loc 8 Brown conn at Hood Release

# MAZDA

Vehicle Year	A Vehicle Manufacturer	B Vehicle Model & Engine Size	C Control Switch/ Throttle Adaptor		D Cruise Control Gray Wire Attachment For VSS Signal
91/92 93/94	Mazda	323 & Protege	250-3421		Loc 1 Independent 18 pin conn above or behind kick panel
92 93	Mazda	626	250-3421	250-4238	Automatic only 22 pin conn of ECM 22 pin conn of ECM-Behind Ashtray
94/95	Mazda	626		250-4238	Loc 7 - Green 18-20 pin conn
92 93	Mazda	MX-3	250-3421		Loc 4 22 pin conn of ECM 5th pos. left to right top row or 26 pin conn 7th position top row
94 95	Mazda	MX-3	250-3421		Loc 4 22 pin conn of ECM 5th Position on top row
92 93	Mazda	MVP	250-3421		Loc 4 22 pin conn of EM 5th pos left to right top row. ECM under carpet on pass. side on some
94/95	Mazda	MVP	250-3421		Pos 1M of PCM loc under passenger floor front of passenger seat
92/93 94/95	Mazda	*MX-5 Miata	250-3421		Loc 8 14 pin conn of auto.trans. control unit or RSW screw on back of speedometer hd.
92/93	Mazda	MX-6	250-3421		22 pin conn of ECM
92/93/95	Mazda	Navajo	250-3421		Loc 13 Wire Harness of transmission
92/93	Mazda	Pickup 2.2L	250-3421		Location 7 back of speedometer



# ISUZU

E Vehicle VSS Wire Color	F VSS Pulses	G Cruise Control Blue Wire Attachment For Tach Signal	H Vehicle Tach Wire Color	I Brake Switch Positive	J Brake Switch Negative
LtGreen/ Yellow	4000	Location 16 Coil	Brown	Green	Green/ Red
White/Black	4000	Location 16 Largest Connector on Coil Pack 2nd Position	Yellow/ Red/Marks	Green	Green/ Red

# MAZDA

E Vehicle VSS Wire Color	F VSS Pulses	G Cruise Control Blue Wire Attachment For Tach Signal	H Vehicle Tach Wire Color	I Brake Switch Positive	J Brake Switch Negative
Green/Red	4000	Location 16 Coil	Yellow/ Blue	Green/ White	Green
Green/Red	4000	Location 16 Coil Location 16 Distributor	Green (Small Connector)	Green/ White	White/Green Green/Black
Green/Red	4000	Location 16 Coil	White/ Black	Green/ White	White/ Green
Black/White	4000	Location 15 Coil	Yellow/ Blue	Yellow/ Red	White/ Green
Violet/Red or Violet/Orange	4000	Location 16 Coil	Yellow/ Blue	Green/ White	Green
Green/Red	4000	Location 5 26 pin connector 10th position left to right	Orange/ Blue	Green/ White	White/ Green
Green/Red	4000	Position 2E of PCM	Yellow	Green/ White	White/ Green
Green/Red	4000	Diagnostic Plug	Black/ White	Green/ White	White/ Green
Green/Red	4000	Location 16 Coil Location 16 Distributor	Yellow/Blue Green	Green/ White	White/ Green
Gray/Black	8000	SPOUT Connector	Pink	Green/ White	White/ Green
"R" Screw	4000	Location 16 Coil	Yellow/ Blue	Green/ White	White/ Green

# MAZDA

Vehicle Year	A Vehicle Manufacturer	B Vehicle Model & Engine Size	C Control Switch/ Throttle Adaptor		D Cruise Control Gray Wire Attachment For VSS Signal
92 93	Mazda	Pickup 2.6L	250-3421		(Manual) Loc 7 back of speedometer or (Auto) 22 pin conn of ECM 5th pos. left to right top row
95	Mazda	Protege & 323	250-3421		Loc 8 - 18 pin independent conn taped to main harness along floor board
94 95	Mazda	B-2300	250-3421		Location 14 Wire harness from transmission
94 95	Mazda	B-3000 B-4000	250-3421		Location 14 Wire harness from transmission

\* Mazda Miata (90-98) Throttle Adaptor **250-4236** when using the **250-1076/250-1222** And **250-4237** when using **250-1176**

**The figures below are to assist in locating VSS signal.  
All pre-1992 applications must be matched by visual comparison only.**

NOTE: This may be a 17 pin connector housing on some 1990-92 models.

13 Pin connector housing (usually Green or White)  
Green w/Red Stripe (VSS Wire)

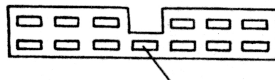

# MAZDA

E Vehicle VSS Wire Color	F VSS Pulses	G Cruise Control Blue Wire Attachment For Tach Signal	H Vehicle Tach Wire Color	I Brake Switch Positive	J Brake Switch Negative
"R" Screw Green/Red	4000	Location 16 Coil	White	Green/ White	White/ Green
Green/Red	4000	Location 16 6 pin conn on distributor	Blue/ Purple	Green/ White	White/ Green
Gray/Black	8000	Location 16 SPOUT	Pink	Green/ White	White/ Green
Gray/Black	8000	Location 15 SPOUT connector or Coil	Pink Tan/Yellow	Green/ Red	Green

# MITSUBISHI

Vehicle Year	A Vehicle Manufacturer	B Vehicle Model & Engine Size	C		D Cruise Control Gray Wire Attachment For VSS Signal
			Control Switch/ Throttle Adaptor		
92 93 94	Mitsubishi	*Eclipse 1.8L	250-3421		Loc 4 Largest connector in ECM 24 pin conn in MFI Pos 18 or 19
92 93 94	Mitsubishi	*Eclipse	250-3421		Loc 4 Largest connector in ECM 24 pin conn in MFI Pos 18 or 19
95	Mitsubishi	Eclipse	250-3421		Loc 5 Pos 14 of 16 pin Data Link Conn. (Diagnostic Connector)
92 93/94/95	Mitsubishi	*Galant	250-3421		Loc 4 Largest connector in ECM 22 pin connector in ECM
92/93 94/95	Mitsubishi	*Mirage	250-3421		Loc 1 Largest connector in ECM 22 pin connector in ECM
92 93	Mitsubishi	*Montero	250-3421		Loc 2 Largest connector in ECM 22 pin connector in ECM
92 93	Mitsubishi	*Pickup 3.0L	250-3421		Loc 1 Largest connector in ECM 22 pin connector in ECM
92 93	Mitsubishi	*Pickup 2.4L	250-3421		Loc 1 Largest connector in ECM 22 pin connector in ECM
93/94 95	Mitsubishi	*Expo	250-3421		22 pin connector in ECM

\*MITSUBISHI BUILT VEHICLES WITH AN AUTOMATIC TRANSMISSION ARE TO BE A PEDAL PULL

**The figures below are to assist in locating the VSS signal.  
All pre-1992 applications must be matched by visual comparison only.**

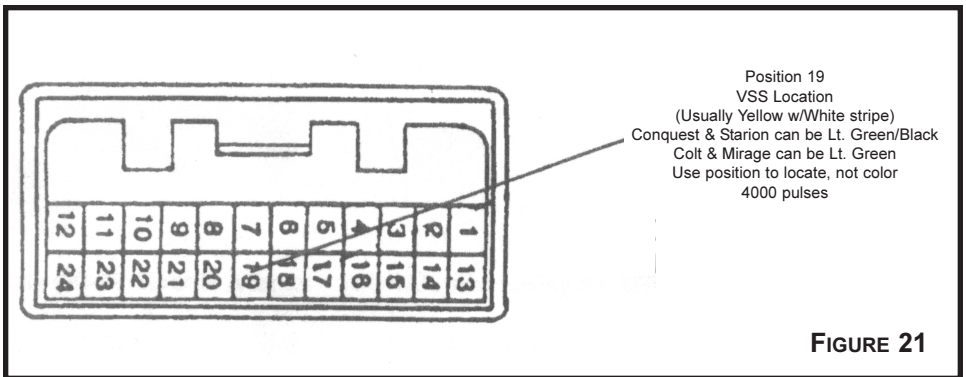

**FIGURE 21**

# MITSUBISHI

E Vehicle VSS Wire Color	F VSS Pulses	G Cruise Control Blue Wire Attachment For Tach Signal	H Vehicle Tach Wire Color	I Brake Switch Positive	J Brake Switch Negative
Yellow/White	4000	Location 16 Tach Filter Location 4 10 pin conn MFI	White	Green/ White	Green
Yellow/White	4000	Loc 16 Largest connector in ECM Loc 10 pin conn MFI	White	Green/ White	Green
Yellow/White	4000	Loc 15 Top 40 pin conn on ECM Position 33	Blue/ Red	Red/ Black	Green
Yellow/White	4000	Location 16 Tach Filter Loc 1 26 pin conn Pos 10	White	Red	Green
Yellow/White	4000	Loc 16 Largest conn in ECM Loc 1 26 pin conn Pos. 10	White	White/ Red	Green
Yellow/White	4000	Location 16 Coil	Blue	Green/ White	Green
Yellow/White	4000	Location 16 Coil	Blue	Green/ White	Green
Yellow/White	4000	Loc 16 2 pin buffer top of engine	White	Green/ White	Green
Yellow/White	4000	26 pin connector at ECM	White	Green/ White	Green

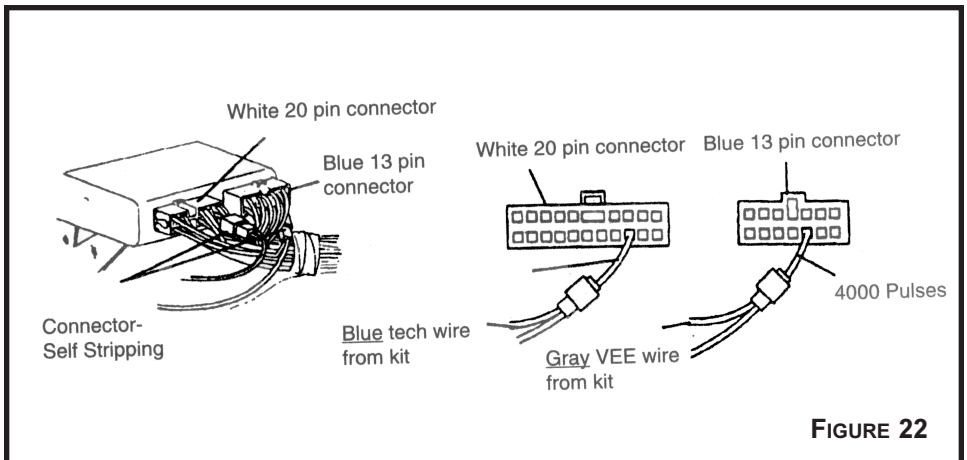

# NISSAN

Vehicle Year	A Vehicle Manufacturer	B Vehicle Model & Engine Size	C Control Switch/ Throttle Adaptor		D Cruise Control Gray Wire Attachment For VSS Signal
95	Nissan	200SX	250-3421		Location 5 position 26 of ECM
92/93	Nissan	240SX	250-3421		Loc 1 8th pos from end of ECM
95	Nissan	240SX	250-3421		Loc 1 pos 26 of ECM
94/95	Nissan	Altima	250-3421		Loc 5 pos 26 of ECM
92 93	Nissan	*Pathfinder	250-3421		Loc 8 upper right multi-junction conn or 8th position from end of ECM conn
94/95	Nissan	NX	250-3421		Loc 5 pos 26 of ECM
92/93	Nissan	NX	250-3421		Loc 1 8th pos from end of ECM
94/95	Nissan	*Pathfinder	250-3421		Loc 8 lower left of multi-junction connector 3rd position
**92 93	Nissan	*Pickup	250-3421		Loc 8 upper right multi-junction connector or 8th pos from end of ECM connector
94/95	Nissan	*Pickup	250-3421		Loc 8 lower left of multi-junction connector 3rd position
93	Nissan	Quest	250-3421		Loc 2 8th pos from end of ECM 116 pin connector
94/95	Nissan	Quest	250-3421		Loc 2 pos 32 of ECM
92/93	Nissan	Sentra	250-3421		Loc 5 8th pos from end of ECM
94/95	Nissan	Sentra	250-3421		Loc 5 pos 26 of ECM
92 93	Nissan	Stanza Stanza Altima	250-3421		Loc 5 8th pos from end of ECM

\*RECOMMENDED PEDAL PULL

\*\*SERIAL #351227 AND ABOVE

# NISSAN

E Vehicle VSS Wire Color	F VSS Pulses	G Cruise Control Blue Wire Attachment For Tach Signal	H Vehicle Tach Wire Color	I Brake Switch Positive	J Brake Switch Negative
Purple/Red	2000	Position 3 of ECM	Blue/Orange		
Yellow/Green	2000	Location 16 Coil Location 1 7th position from Center	Lt.Green/Black White	Red/ Yellow	Red/ Green
Yellow/Green	2000	Position 3 of ECM	Yellow/ Red	Red/ Yellow	Red/ Green
Yellow/Green	2000	Position 3 of ECM	Yellow/Red/ Blue/Black		
White/Blue White/Yellow	2000	Location 16 Coil Location 1 7th pos from center	Lt. Green/Black White	Red/ Yellow	Red/ Green
Purple/Red	2000	Position 3 of ECM	Blue/ Orange	Red/ Yellow	Red/ Green
Yellow/Green	2000	Location 16 Coil 7th pos from center of ECM	Blue White/Black	Red/ Black	Green/ Yellow
White/Blue	2000	Location 16 Coil	Blue	Red/ Black	Green/ Yellow
White/Blue White/Yellow	2000	Location 16 Coil 7th pos from center of ECM	Blue or White	Red/ Black	Green/ Yellow
White/Blue	2000	Location 16 Coil Under Passenger seat Pos 3 at ECM	Blue White	Red/ Black	Green/ Yellow
Green/Yellow	2000	Location 2 6th pos from center of 116 pin ECM connector	Green/ White	Red/ Black	Green/ Yellow
Green/Yellow	2000	Position 2 of ECM	Green/ White	Red/ White	Yellow/ Black
Yellow/Green	2000	Location 16 Coil Loc 5 7th position from center	Green/Yellow White	Green/ Yellow	Red/ Green
Purple/Red	2000	Position 3 of ECM	Blue/ Orange	Green/ Yellow	Red/ Green
Yellow/Green	2000	Location 16 Coil Location 5 7th pos from center	Lt.Green/ Black	Lt.Green/ Black	Red/ Green

# NISSAN

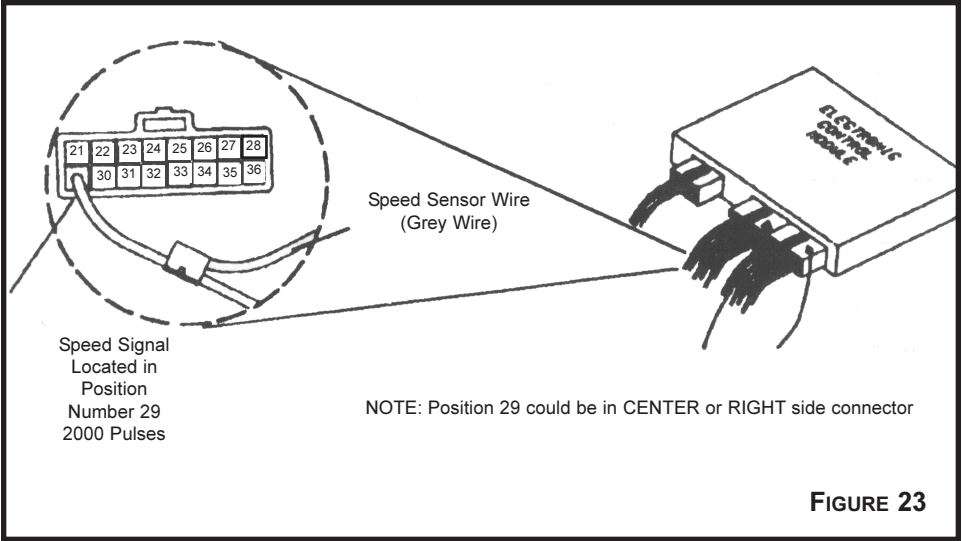

## NISSANS with 4 plugs in the Electronic Control Module

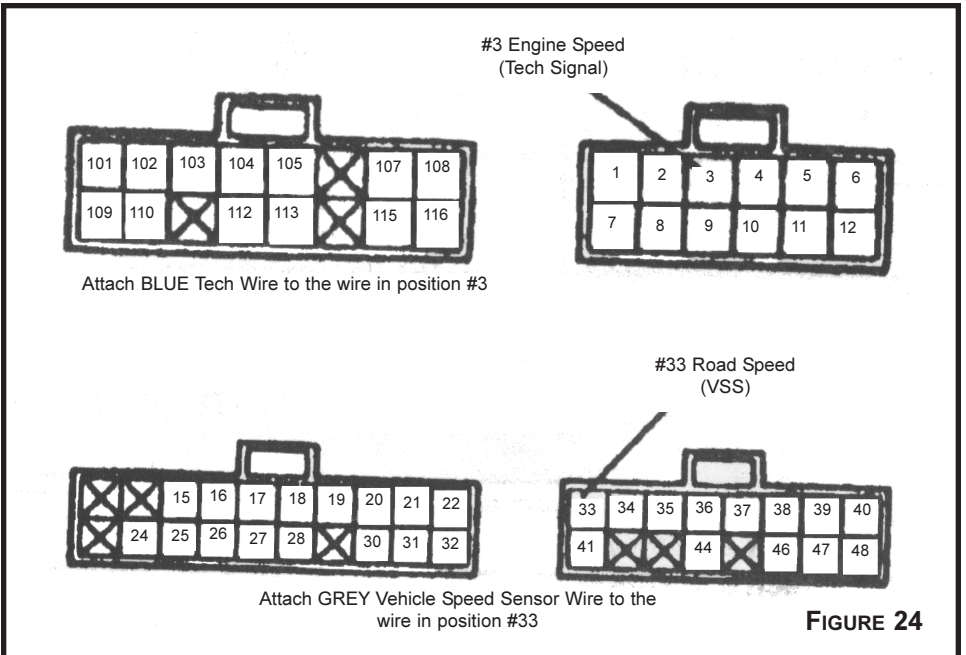



# NISSAN

Tach = Brown w/ Stripe  
 Tach = Yellow w/ Red Stripe  
 Tach = White/Green Stripe and Silver Dots

VSS = Yellow w/ Red Stripe  
 VSS = Yellow w/ Green Stripe  
 VSS = White w/ Blue Stripe and Silver Dots

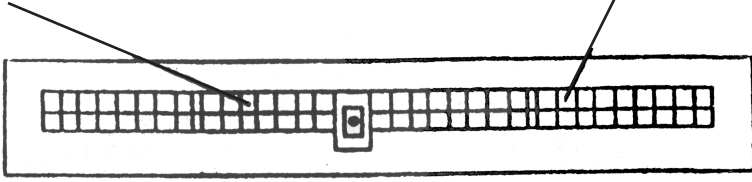

(Wire Side of plug)

FIGURE 25

Tach = Green/White

VSS = Green/Yellow

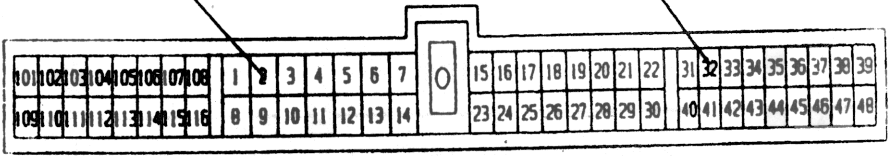

(Wire side of plug)

FIGURE 26

Tach = Yellow/Red  
 Tach = Blue/Orange  
 Tach = White  
 Tach = Blue/Black

VSS = Yellow/Green  
 VSS = Purple/Red  
 VSS =

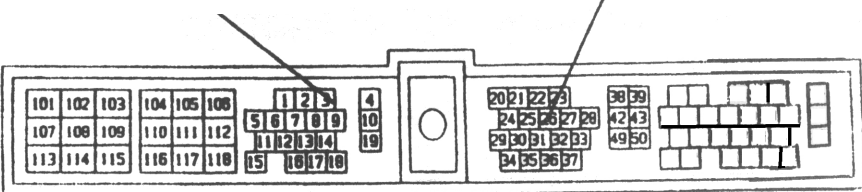

(Wire side of plug)

FIGURE 27

## SUBARU

Vehicle Year	A Vehicle Manufacturer	B Vehicle Model & Engine Size	C		D Cruise Control Gray Wire Attachment For VSS Signal
			Control Switch/ Throttle Adaptor		
92	Subaru	Justy MPFI	250-3421		Loc 6 Pos 9 of 16 pin conn in ECM
92	Subaru	Justy EFC	250-3421		Loc 6 Pos of 22 pin conn in ECM
92	Subaru	XT6	250-3421		Loc 6 Pos 9 of 16 pin conn in ECM
92 93	Subaru	Legacy	250-3421		Loc 2 20 pin independent conn or Loc 6 corner wire of connector closes to dash in ECM
92	Subaru	Loyale	250-3421		Loc 6 17 pin independent connector (Corner Position)
93 94	Subaru	Impreza	250-3421		4th pos of 26 pin conn (closest to seat) at ECM on passenger floor

## SUZUKI

Vehicle Year	A Vehicle Manufacturer	B Vehicle Model & Engine Size	C		D Cruise Control Gray Wire Attachment For VSS Signal
			Control Switch/ Throttle Adaptor		
92/93 94	Suzuki	*Sidekick	250-3421		Loc 8 pos. Y-15 of yellow conn in ECM (Smaller Connector)
92 93/94	Suzuki	*Swift	250-3421		Loc 8 connector above fuse panel

## TOYOTA

Vehicle Year	A Vehicle Manufacturer	B Vehicle Model & Engine Size	C		D Cruise Control Gray Wire Attachment For VSS Signal
			Control Switch/ Throttle Adaptor		
92/93 94/95	Toyota	4/Runner	250-3421	250-4207 (88-95)	Loc 1 Right connector in ECM
92/93 94/95	Toyota	Camry 2.2L	250-3421	250-4212 (92-96)	Loc 2 Right connector in ECM
92 93	Toyota	Celica SL 1.6L	250-3421	250-4204 (90-93)	Loc 4 Right connector in ECM
94 95	Toyota	Celica 1.8L	250-3421	250-4234 (94-97)	Loc 4 Pos 9 of 22 pin conn or Pos 11 of 12 pin conn

\*RECOMMENDED PEDAL PULL

# SUBARU

<b>E</b> Vehicle VSS Wire Color	<b>F</b> VSS Pulses	<b>G</b> Cruise Control Blue Wire Attachment For Tach Signal	<b>H</b> Vehicle Tach Wire Color	<b>I</b> Brake Switch Positive	<b>J</b> Brake Switch Negative
Yellow/Green	4000	Location 16 Ignition Coil	Neg.Side	Red/ Yellow	Green/ White
Lt.Green/Black	4000	Location 16 Ignition Coil	Neg.Side	Red/ Green	Green
Yellow/Red	4000	Location 16 Ignition Coil	Neg.Side	Red/ Green	Green
Green/Black Black/Blue	4000	Location 16 Ignition Coil	Blue/ Red Dots	Red/ Green	Green
Yellow/Red	4000	Location 16 Ignition Coil	Blue/ Red	Red/ Green	Green
Green/Black	4000	Location 16 Ignition Coil	Neg.Side	Red/ Green	Green

# SUZUKI

<b>E</b> Vehicle VSS Wire Color	<b>F</b> VSS Pulses	<b>G</b> Cruise Control Blue Wire Attachment For Tach Signal	<b>H</b> Vehicle Tach Wire Color	<b>I</b> Brake Switch Positive	<b>J</b> Brake Switch Negative
Yellow Yellow/ Silver Dots	4000	Location 16 Ignition Coil	Brown/ White	Green	Green/ White
Yellow/Green	4000	Location 16 Ignition Coil	Brown/ White	White/ Yellow	Green/ White

# TOYOTA

<b>E</b> Vehicle VSS Wire Color	<b>F</b> VSS Pulses	<b>G</b> Cruise Control Blue Wire Attachment For Tach Signal	<b>H</b> Vehicle Tach Wire Color	<b>I</b> Brake Switch Positive	<b>J</b> Brake Switch Negative
Green/Blue	4000	Location 11 Diagnostic connector	Black	Green/ Red	Green/ White
Violet/Yellow	4000	Location 18 Coil	Black	Green/ Red	Green/ White
Blue/White	4000	Location 13 Igniter	Black	Green/ Red	Green/ White
Orange	4000	Location 16 Coil	Black	Green/ Red	Green/ White

# TOYOTA

Vehicle Year	A Vehicle Manufacturer	B Vehicle Model & Engine Size	C		D Cruise Control Gray Wire Attachment For VSS Signal
			Control Switch/ Throttle Adaptor		
92 93	Toyota	Celica 2.2L GT/GTS	250-3421	250-4234 (90-93)	Location 4 Right conn in ECM
94 95	Toyota	Celica 2.2L	250-3421	250-4235 (94-97)	Location 4 Pos 9 of 22 pin conn or Position 11 of 12 pin conn
92	Toyota	Corolla (except GTS)	250-3421	250-4199	Location 5 Right conn in ECM
93/94 95	Toyota	Corolla	250-3421	250-4219 (93-97)	Transaxle 3 pin plug OR under coin tray Black 22 pin conn Pos 9
92	Toyota	Landcruiser (PEDAL PULL)	250-3421		Location 2 Pos 11 of 12 pin conn in ECM
92/93 94/95	Toyota	Paseo	250-3421	250-4246 (95-96)	Use cruise control kit #250-1159 ONLY
92/93 94/95	Toyota	Pickup 4/6 cyl.	250-3421	250-4207 (88-95)	Location 1 Right connector of ECM
95	Toyota	Tacoma 4 cyl.	250-3421	250-3417	Location 2 Pos 8 or 9 of 22 pin conn
95	Toyota	Tacoma V6 (Except Manual 4x4)	250-3421	250-4244	Loc 2 Pos 8 or 9 of 22 pin conn
95	Toyota	Tacoma V6 Man 4x4	250-3421	250-4245	Loc 2 Pos 8 or 9 of 22 pin conn
92 93/94	Toyota	Tercel	250-3421	250-4211 (91-94)	Loc 4 16 pin conn at ECM Pos 13 or 22 pin conn, Pos 9
95	Toyota	Tercel	250-3421 250-4246	(95)	Loc 2 Pos 13 of 16 pin conn Of ECM or Pos 9 of 22 pin conn
93 94	Toyota	T-100	250-3421	250-4221 (93-94)	Loc 1 22 pin conn at ECM
95	Toyota	T-100 4 cyl	250-3421	250-4243 (95)	Loc 1 Pos 8 or 9 of 22 pin conn at ECM or Pos 12 of 28 pin conn.
95	Toyota	T-100 6 cyl	250-3421 250-4244	(95)	Loc 1 Pos 8 or 9 of 22 pin conn at ECM or Pos 12 of 28 pin conn

# TOYOTA

E Vehicle VSS Wire Color	F VSS Pulses	G Cruise Control Blue Wire Attachment For Tach Signal	H Vehicle Tach Wire Color	I Brake Switch Positive	J Brake Switch Negative
Blue/White	4000	Location 13 Igniter	Black	Green/ Red	Green/ White
Orange	4000	Location 16 Coil	Black	Green/ Red	Green/ White
Violet/White	4000	Location 16 Coil	Black	Red/ White	Green/ White
Red/Yellow Violet/White	4000	Location 16 Coil near Driver's Shock Tower	Black	Red/ White	Green/ White
Black/Red	4000	Location 16 Coil	Black/ White	Green/ Blue	Green/ White
Green/Blue	4000	Location 11 Diagnostic Connector	Black	Green/ Red	Green/ White
Green/Orange	4000	Loc 2 26 pin conn - Pos 15	Black	Green/ Red	Green/ White
Green/Orange	4000	Loc 17 Igniter on fenderwell	Black	Green/ Red	Green/ White
Green/Orange	4000	Loc 17 Igniter on fenderwell	Black	Green/ Red	Green/ White
Yellow/ Silver Dots	4000	Location 13 Coil	Black/ Blue	White/ Green	Green/ White
Yellow/ Silver Dots	4000	Location 13 Igniter	Black/ Blue	Green/ Red	Green/ White
Green/Blue or Green	4000	Location 14 Coil Location 17 Diag Plug IGT. Pos.	Black Black/Red	Green/ Red	Green/ White
Green	4000	Loc 17 Passenger side fenderwell Igniter	Black	Green/ Red	Green/ White
Green	4000	Loc 17 Passenger side fenderwell Igniter	Black	Green/ Red	Green/ White

# TOYOTA

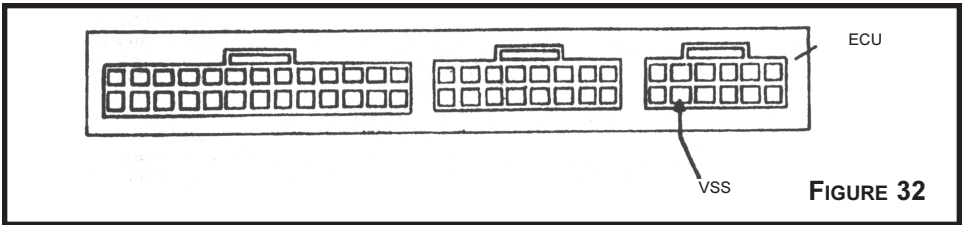
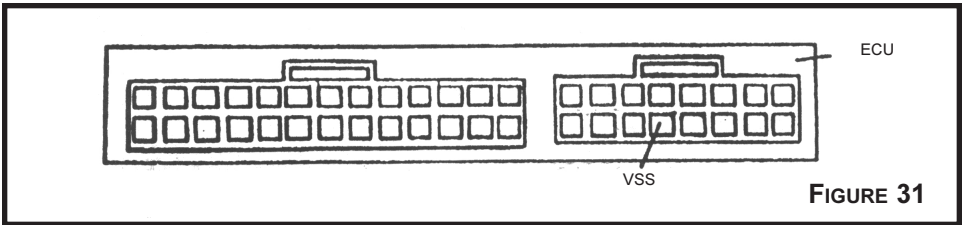
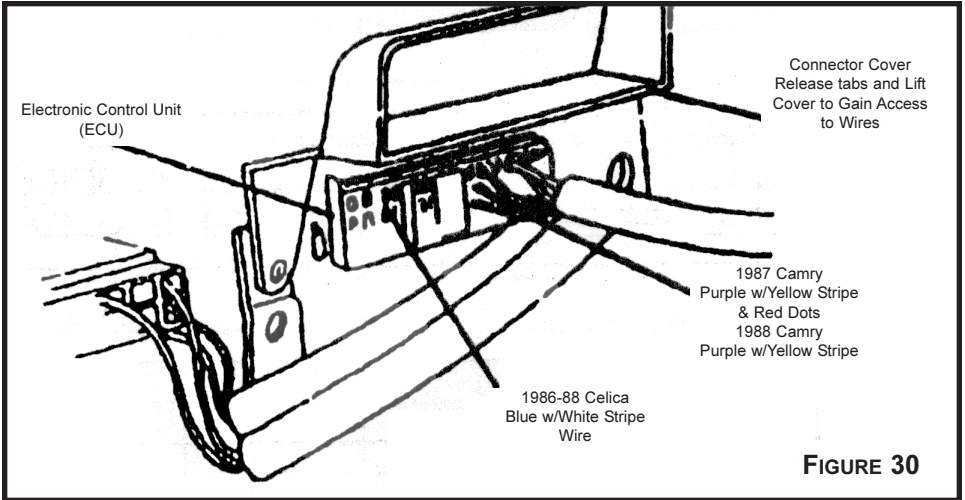
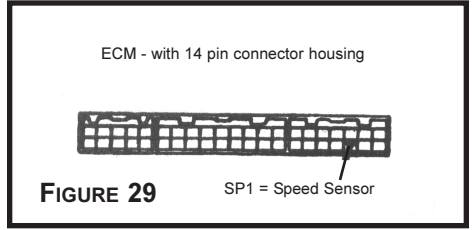
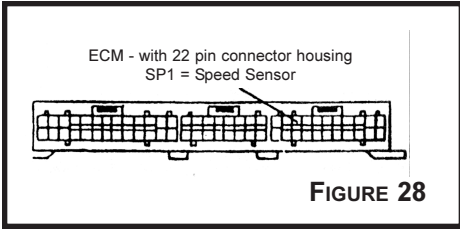

## VOLKSWAGEN

Vehicle Year	A Vehicle Manufacturer	B Vehicle Model & Engine Size	C Control Switch/ Throttle Adaptor		D Cruise Control Gray Wire Attachment For VSS Signal
93/94 95	Volkswagen	Golf	250-3084		Loc 13 3 wire conn on transaxle
93/94 95	Volkswagen	Jetta	250-3084		Loc 13 3 wire conn on transaxle

## VOLKSWAGEN

E Vehicle VSS Wire Color	F VSS Pulses	G Cruise Control Blue Wire Attachment For Tach Signal	H Vehicle Tach Wire Color	I Brake Switch Positive	J Brake Switch Negative
White/Blue	8000	Location 16 Ignition Coil	Black/ Red	Red/ Yellow	Red/ Black
White/Blue	8000	Location 16 Ignition Coil	Black/ Red	Red/ Yellow	Red/ Black