

**KIT CONTENTS**

ITEM	QTY	DESCRIPTION
1	2	HEATING ELEMENT
2	1	CONTROL SWITCH
3	1	MAIN HARNESS
4	1	HARDWARE BAG
5	1	WARRANTY CARD
<b>CONTROL SWITCH OPTIONS</b>		
ROUND SWITCH, SWITCH EXT HARN & POWER HARN		
SINGLE DIAL SWITCH & POWER HARNESS		
DUAL DIAL SWITCH & POWER HARNESS		

**HARDWARE BAG CONTENTS**

<b>ROUND SWITCH KIT</b>		
ITEM	QTY	DESCRIPTION
1	8	WIRE TIES
2	4	INSULATED TAPE
3	2	14-16AWG SPADE TERMINAL
4	2	14-16AWG T-TAP
<b>SINGLE-DIAL SWITCH KIT</b>		
1	8	WIRE TIES
2	4	INSULATED TAPE
3	3	14-16AWG SPADE TERMINAL
4	3	14-16AWG T-TAP
<b>DUAL-DIAL SWITCH KIT</b>		
1	16	WIRE TIES
2	8	INSULATED TAPE
3	4	14-16AWG SPADE TERMINAL
4	4	14-16AWG T-TAP

**CONFLICTS**

<b>NOTE:</b>
--------------

**RECOMMENDED TOOLS**

SAFETY TOOLS	USE DURING INSTALL
GLOVES	
SAFETY GLASSES	
<b>SPECIAL TOOLS</b>	
<b>INSTALLATION TOOLS</b>	
PLIERS	FOR T-TAPS
WIRE CUTTERS	TO CUT WIRE TIES
TRIM REMOVAL TOOL	
SCISSORS	FOR CUTTING ELEMENTS
<b>SPECIAL CHEMICALS</b>	

**GENERAL APPLICABILITY**

ALL MODELS EXCEPT VERTICAL CENTER LISTING







**RECOMMENDED SEQUENCE OF APPLICATION**

\* MANDATORY

**SPECIAL NOTE: INSTALLATION SEQUENCES**

AFTER **SAFETY** MANDATED PREPARATORY STEPS HAVE BEEN TAKEN, THE INSTALLATION SEQUENCE IS THE SUGGESTED METHOD FOR COMPLETING THE ACCESSORY INSTALLATION. IN SOME INSTANCES, THE SUGGESTED SEQUENCE IS WRITTEN FOR ONE ASSOCIATE TO INSTALL AND IN OTHERS THE SEQUENCE IS GIVEN AS PART OF A TEAM ACCESSORY INSTALLATION. UNLESS OTHERWISE STATED IN THE DOCUMENT, THE ASSOCIATES MAY PERFORM THE INSTALLATION STEPS IN ANY ORDER TO MAKE THE INSTALLATION AS EFFICIENT AS POSSIBLE WHILE MAINTAINING CONSISTENT QUALITY.

**LEGEND**

	<b>STOP:</b> DAMAGE TO VEHICLE MAY OCCUR. DO NOT PROCEED UNTIL PROCESS COMPLIANCE HAS BEEN MET.
	<b>OPERATOR SAFETY:</b> USE CAUTION TO AVOID RISK OF INJURY.
	<b>CRITICAL PROCESS:</b> PROCEED WITH CAUTION TO ENSURE A QUALITY INSTALLATION. THESE POINTS WILL BE AUDITED ON A COMPLETED VEHICLE INSTALLATION.
	<b>GENERAL PROCESS:</b> THIS HIGHLIGHTS SPECIFIC PROCESSES TO ENSURE A QUALITY INSTALLATION. THESE POINTS WILL BE AUDITED DURING THE ACCESSORY INSTALLATION.
	<b>TOOLS &amp; EQUIPMENT:</b> THIS CALLS OUT THE SPECIFIC TOOLS AND EQUIPMENT REQUIRED FOR THE PROCESS.
	<b>REVISION MARK:</b> THIS MARK HIGHLIGHTS A CHANGE IN INSTALLATION WITH RESPECT TO PREVIOUS ISSUE.

**!!!WARNING!!!**  
**SEAT HEATERS SHOULD NOT BE INSTALLED IN VEHICLES THAT WILL BE USED BY INDIVIDUALS THAT MAY EXPERIENCE DIFFICULTY WITH SENSING AND/OR REACTING TO INCREASED TEMPERATURE (PARAPLEGICS, INFANTS, ELDERLY, ETC.)**

# GENERAL SAFETY ADVICE

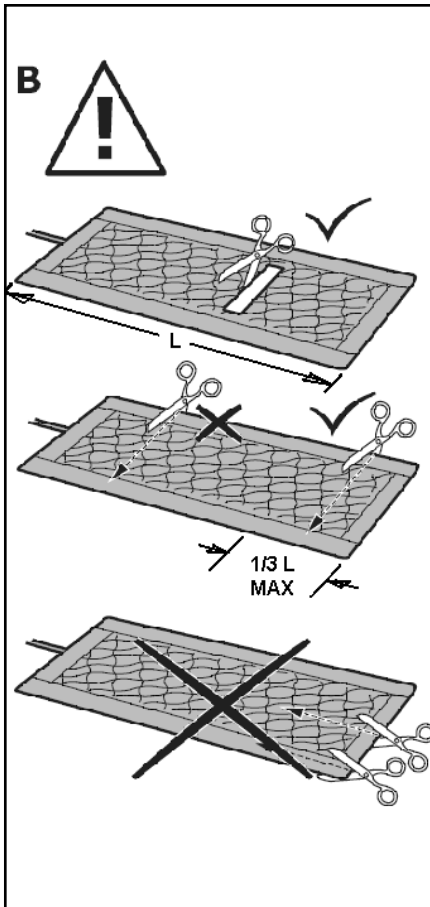
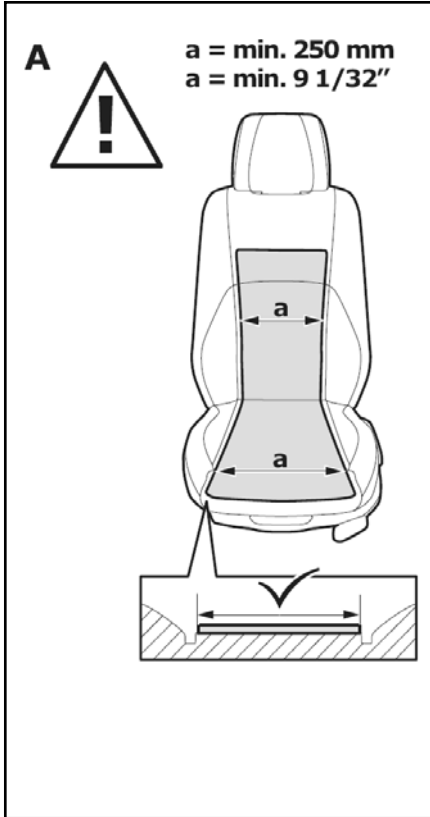

- IT IS IMPOSSIBLE TO INSTALL THE SEAT HEATING KITS WHENEVER:
  - THE SEAT COVERS ARE ADHERED TO THE SEAT'S FOAM PADDING, OR
  - THE SEAT'S LONGITUDINAL CHANNELS ARE SPACED LESS THAN 250 MM APART (**FIG. A**).
- THE BATTERY TERMINALS SHOULD BE DISCONNECTED BEFORE WORKING ON THE VEHICLE'S ELECTRICAL CIRCUITS. THE SECURITY CODES (RADIO, NAVIGATION SYSTEM, ETC.) SHOULD BE NOTED.
- THE SEAT COVER AND SEAMS SHOULD REMAIN UNMODIFIED FOR SEATS WITH SIDE AIR-BAGS. THE HEATING ELEMENTS ARE ONLY ALLOWED TO BE FITTED IN THE MIDDLE OF THE SEAT. PLEASE REFER TO THE VEHICLE MANUFACTURER'S MANUAL.
- PLEASE FOLLOW THE VEHICLE MANUFACTURER'S VEHICLE MANUAL FOR SEATS WITH A SEAT BELT RECOGNITION DEVICE, A SEAT OCCUPANT CLASSIFICATION SYSTEM (OCS)/OCCUPANT POSITION DETECTION SYSTEM (OPDS), OR BOTH.
  - \* FOLLOW THE EXAMPLE OF WHAT THE FACTORY DOES.
  - \* DO NOT PLACE A SEAT HEATER PAD ON TOP OF THE OCS/OPDS. INSTALL THE PAD ON THE FOAM CORE WHICH IS NOT EQUIPPED WITH THE SENSOR.
  - \* DISCONNECT THE OTHER PAD, YOU WILL NOT NEED IT. IF INSTALLING THE ROUND 3-POSITION SWITCH, CONNECT THE PAD WHICH PROVIDES 2-COLOR SWITCH ILLUMINATION. NOTE: HEAT WILL ONLY BE PRODUCED IN THE "HI" SETTING.
- THE SEAT HEATING ELEMENTS ARE ONLY ALLOWED TO BE INSTALLED BY QUALIFIED AND TRAINED PERSONNEL WHO ARE KNOWLEDGEABLE ABOUT ELECTRONIC SYSTEMS AND UPHOLSTERY. IMPROPER INSTALLATION CAN ADVERSELY AFFECT THE SYSTEM'S RELIABILITY AND RISK OVERHEATING.
- USE ORIGINAL KIT COMPONENTS ONLY.
- THE HEATING ELEMENTS MUST BE SECURED AND MOUNTED FREE OF FOLDS AND CREASES. HEATING ELEMENTS ARE NOT ALLOWED TO BE DAMAGED DURING THE INSTALLATION. AVOID EXPOSURE TO ANY SHARP OBJECT THAT COULD COMPROMISE THE INTEGRITY OF THE HEATING ELEMENT. IT IS IMPERATIVE FOR DURABILITY AND THE SYSTEM'S RELIABILITY THAT THE COMPLETE HEATING ELEMENT IS POSITIONED CORRECTLY. ANY MODIFICATIONS TO THE SEAT'S COMPONENTS, WHICH AFFECT THE HEATING ELEMENTS OR COME INTO CONTACT WITH THEM, CAN INFLUENCE THE DURABILITY AND RELIABILITY.
- THE HEATING ELEMENT IS ONLY ALLOWED TO BE OPERATED AT  $+12\text{ V} \pm 3\text{ V}$ . IT SHOULD IDEALLY BE CONNECTED TO THE ON BOARD POWER SUPPLY VIA THE IGNITION VOLTAGE. THE SEAT HEATING UNIT SHOULD BE PROTECTED BY A FUSE WITH A MAXIMUM RATING OF 15 AMPS.
- THE HEATING ELEMENTS ARE ONLY ALLOWED TO BE MODIFIED AS DESCRIBED IN THESE INSTALLATION INSTRUCTIONS, EXCEPT WIDTH WHICH IS NOT ALLOWED TO BE ALTERED IN ANY WAY. **Do not** REMOVE MORE THAN  $1/3$  THE SURFACE AREA OF THE ELEMENT.
- THE WIRE HARNESS IS NOT ALLOWED TO BE MODIFIED. ENSURE THAT THE WIRE HARNESS IS SECURED AND FASTENED PROPERLY. THE WIRE HARNESS MUST BE ROUTED PROPERLY SO THE SEAT CAN MOVE FREELY WITHOUT DIFFICULTY. CONTACT WITH SHARP EDGES, BENDING OR PULLING OF WIRE MUST BE AVOIDED, IN ORDER TO PREVENT THE WIRE HARNESS FROM BEING DAMAGED. THE ON BOARD MAIN SUPPLY AND THE WIRE HARNESS CROSS-SECTION MUST BE ADAPTED TO THE EXTRA CURRENT LOADS IF NECESSARY. REFER TO THE VEHICLE'S WIRING DIAGRAM FOR ADDITIONAL INFORMATION.
- THE FOAM PADDING MUST BE CLEAN AND FREE FROM SEPARATING AGENTS, GREASE, SILICONE, DUST AND OIL BEFORE THE HEATING ELEMENTS ARE SECURED TO IT. THE FULL ADHESIVE STRENGTH WILL ONLY BE ATTAINED IF SUFFICIENT PRESSURE IS APPLIED DURING THE INSTALLATION AND AN ADEQUATE PERIOD OF TIME IS ALLOWED FOR THE CHEMICAL REACTION TO TAKE PLACE (48 HOURS APPROX.). A HEATING ELEMENT IS NOT ALLOWED TO BE DETACHED AND REINSTALLED AFTER IT HAS BEEN INSTALLED COMPLETELY FOR THE FIRST TIME.
- THE HEATING ELEMENTS ARE NOT ALLOWED TO COME INTO CONTACT WITH ANY OF THE SEAT'S ELECTRICALLY CONDUCTIVE COMPONENTS SUCH AS PADDING CLIPS/HOGRINGS, LISTING SUPPORTS OR THE SEAT'S FRAME: **!!!DANGER OF SHORT-CIRCUITING!!!**
- THE HEATING PERFORMANCE ON THE COVER'S SURFACE VARIES ACCORDING TO THE TYPE OF SEAT OR COVER. EVERY MILLIMETER OF THE COVER'S THICKNESS PROLONGS THE HEATING TIME BY UP TO 15 SECONDS.
- THE SEAT HEATING UNIT'S FUNCTION MUST BE EXPLAINED TO THE CUSTOMER AND THE OPERATING INSTRUCTIONS MUST BE PROVIDED. THE CUSTOMER MUST BE INFORMED ABOUT ALL SAFETY ASPECTS. THE OPERATING INSTRUCTIONS MUST DESCRIBE HOW THE FUSE IS POSITIONED.
- THE POINTS IN THE OPERATING INSTRUCTIONS MUST ALSO BE FOLLOWED FOR THE INSTALLATION.

**WARNING: SEAT HEATERS SHOULD NOT BE INSTALLED IN VEHICLES THAT WILL BE USED BY INDIVIDUALS THAT MAY EXPERIENCE DIFFICULTY WITH SENSING AND/OR REACTING TO INCREASED TEMPERATURE (PARAPLEGICS, INFANTS, ELDERLY, ETC.)**

# INSTALLATION



**CAUTION: It is advisable to disconnect the negative battery cable for 3 minutes before beginning installation to avoid unintended air bag deployment. Note and record any anti-theft radio codes prior to disconnecting.**

## A. PRE-INSTALLATION SUGGESTIONS



1. REMOVE SEATS FROM VEHICLE PER VEHICLE'S SERVICE MANUAL AND PLACE ON A CLEAN WORK SURFACE.
2. REMOVE SEAT COVERS PER VEHICLE'S SERVICE MANUAL.

## B. TRIMMING HEATING ELEMENTS



1. PLACE HEATING ELEMENT ON SEAT CUSHION TAPE SIDE DOWN, WITH HARNESS TOWARD SEAT BACK. IF THE SEAT HAS A CENTER LISTING OR LISTINGS, FORM THE ELEMENT INTO THE LISTING(S) VALLEY(S). **FIGURE 2.**

**NOTE: MAKE SURE THERMOSTAT IS NOT LOCATED UNDER THE SEAT BACK OR IN A LISTING VALLEY. IT IS RECOMMENDED TO LOCATE THERMOSTAT 1-2" FROM THE EDGE OF THE SEAT BACK.**

2. DRAW A WINDOW AROUND THE LOCATION OF THE CENTER LISTING. ALLOW 1/8" (3MM) ON EITHER SIDE OF THE LISTING CHANNEL. DO NOT EXCEED 7/8" MAXIMUM WINDOW WIDTH.

**NOTE: LEAVE AT LEAST 1 5/8" (40MM) OF SEAT HEATER MATERIAL TO EACH SIDE OF THE OPENING. FIGURE 3.**

IF IT IS NOT POSSIBLE TO LEAVE AT LEAST 1 5/8" MATERIAL ON EITHER SIDE OF THE LISTING, IT IS ACCEPTABLE TO CUT THE ELEMENT TO FIT THE LENGTH. **CAUTION: DO NOT REMOVE MORE THAN 7" OF ELEMENT LENGTH. THE FINISHED ELEMENT SHOULD BE NO LESS THAN 11.75".**

3. REPEAT STEPS 1 & 2 FOR SEAT BACK CUSHION.
4. TRIM THE PADS AND DISCARD THE EXCESS MATERIAL. **FIGURE 4.**

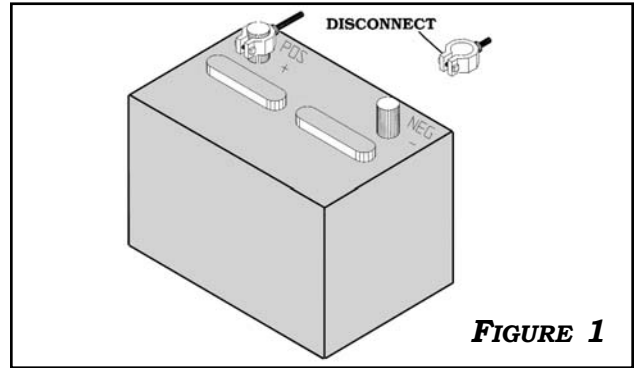

**FIGURE 1**

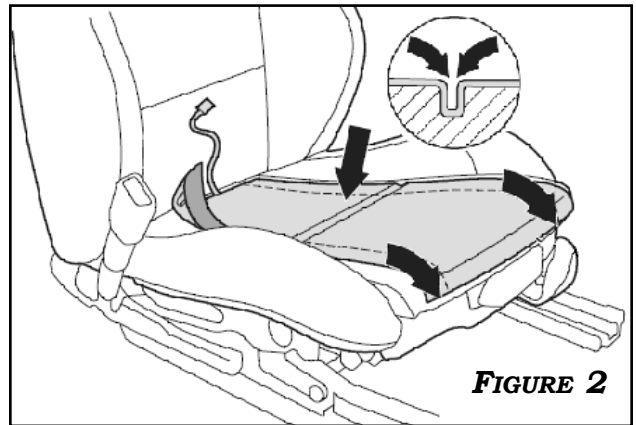

**FIGURE 2**

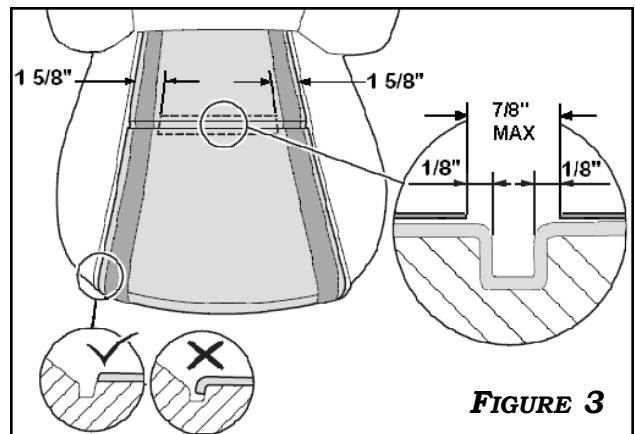

**FIGURE 3**

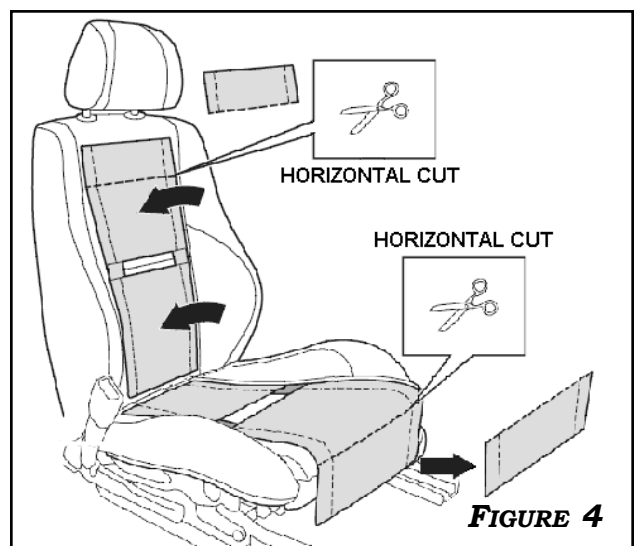
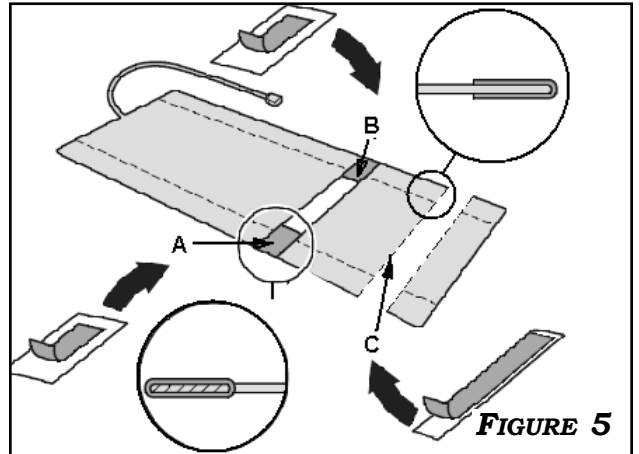

**FIGURE 4**

# INSTALLATION

## B. TRIMMING HEATING ELEMENTS (CONTINUED)

5. USING THE SUPPLIED FELT OR MYLAR TAPE, WRAP EDGES **A** AND **B** OF THE CUT OUT WINDOW AS SHOWN IN **FIGURE 5**.
6. USING THE SUPPLIED 2" STRIPS OF FELT OR MYLAR TAPE, WRAP THE CUT EDGE **C** AS SHOWN. SEE **FIGURE 5**.



## C. INSTALLATION OF HEATING ELEMENTS



1. **CAUTION: THE HEATING ELEMENTS MUST BE INSTALLED FLAT, UNFOLDED AND WRINKLE FREE. DO NOT FOLD ELEMENT AND INSTALL.**
2. REMOVE THE TAPE'S PROTECTIVE LAYER AND CENTER THE ELEMENT SIDE TO SIDE ON THE SEAT BACK FOAM. POSITION THE THERMOSTAT APPROXIMATELY 1-2" FROM THE OPPOSITE CUSHION. WORKING FROM THE BACK TO THE FRONT OR FRONT TO BACK, PRESS FIRMLY ON THE ELEMENT TO ENSURE A GOOD BOND WITH THE SEAT CUSHION AND TO AVOID WRINKLES. **FIGURE 6**
3. CUT A SMALL INCISION IN THE FOAM FOR THERMOSTAT LOCATION. **FIGURE 7**
4. ROUTE THE ELEMENT WIRING HARNESS DOWN TO THE BOTTOM OF THE SEAT BACK, INBOARD OF THE HINGE COVER AND UNDER THE SEAT. BE SURE HARNESS IS FREE FROM SHARP OBJECTS, PINCH POINTS AND MOVING PARTS.
5. REPEAT THE PROCESS ABOVE FOR THE SEAT CUSHION.
6. SECURE WIRING HARNESSES UNDER SEAT. BE SURE HARNESS IS FREE FROM SHARP EDGES, PINCH POINTS AND MOVING OBJECTS.
7. RE-ATTACH SEAT COVERS. TAKE CARE TO AVOID DAMAGE TO THE HEATING ELEMENTS.

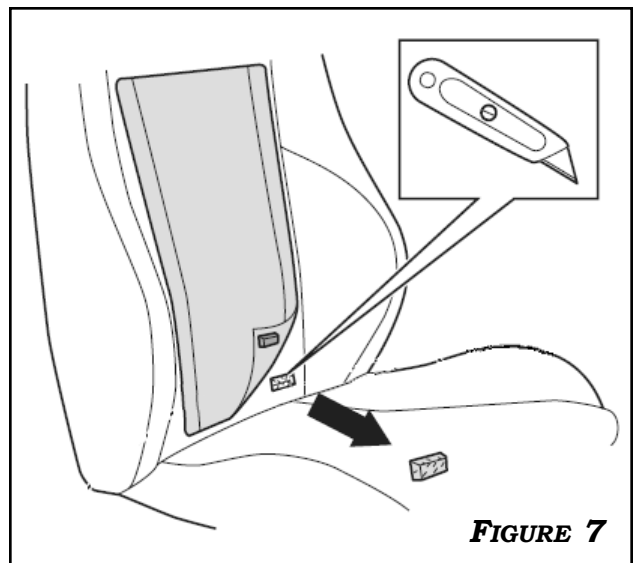
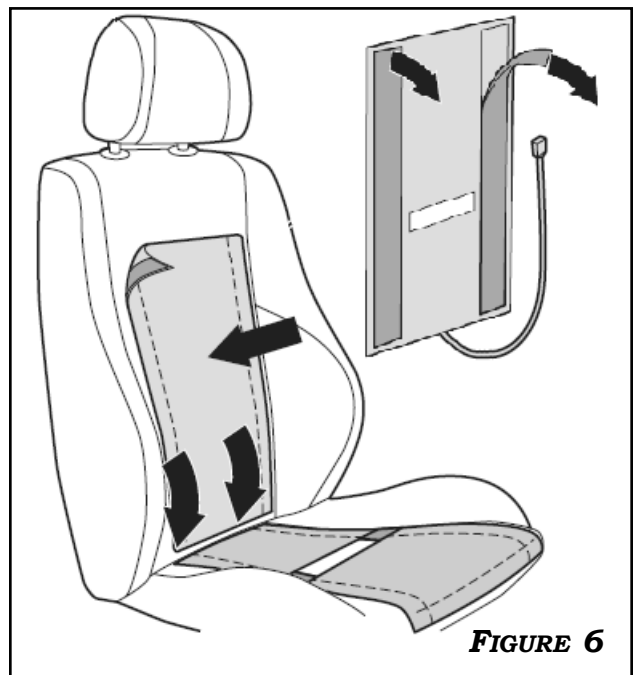

### **CAUTION: DANGER OF SHORT-CIRCUITING!**

THE HEATING ELEMENTS ARE NOT ALLOWED TO COME INTO CONTACT WITH ANY OF THE SEAT'S ELECTRICALLY CONDUCTIVE COMPONENTS SUCH AS PADDING CLIPS/HOGRINGS, LISTING SUPPORTS OR THE SEAT'S FRAME!

# INSTALLATION

## D. HARNESS INSTALLATION



1. PRIOR TO MAKING ANY CONNECTIONS, LAY OUT THE HARNESS IN THE VEHICLE TO FIND THE BEST SOLUTION FOR HARNESS ROUTING TO POWER CONNECTIONS AND SWITCH LOCATION.
2. REFER TO VEHICLE OWNER'S MANUAL FOR ANY WIRING IDENTIFICATION. USING THE SUPPLIED T-TAPS AND INSULATED TERMINALS, CONNECT THE WIRE HARNESS TO THE VEHICLE WIRING AS FOLLOWS:

### ROUND SWITCH KIT

- A. RED WIRE - CONNECT TO ACCESSORY +12 VOLTS - 10 AMP CIRCUIT.

**NOTE:** IMPROPER INSTALLATION COULD LEAD TO BATTERY DRAIN IF CONNECTED TO A CONSTANT BATTERY SOURCE.

- B. BLACK WIRE - IT IS RECOMMENDED TO CONNECT THE RING TERMINAL TO THE VEHICLE BODY USING AN EXISTING COMMON GROUND POINT. IF ONE IS NOT ACCESSIBLE, CONNECT TO A GROUND WIRE WITH HIGH CURRENT CAPACITY.

### SINGLE-DIAL SWITCH KIT

- A. RED WIRE - CONNECT TO ACCESSORY +12 VOLTS - 10 AMP CIRCUIT.

**NOTE:** IMPROPER INSTALLATION COULD LEAD TO BATTERY DRAIN IF CONNECTED TO A CONSTANT BATTERY SOURCE.

- B. RED/YELLOW STRIPE WIRE - CONNECT TO IGNITION +12 VOLTS - 5 AMP CIRCUIT.

- C. BLACK WIRE - IT IS RECOMMENDED TO CONNECT THE RING TERMINAL TO THE VEHICLE BODY USING AN EXISTING COMMON GROUND POINT. IF ONE IS NOT ACCESSIBLE, CONNECT TO A GROUND WIRE WITH HIGH CURRENT CAPACITY.

### DUAL-DIAL SWITCH KIT

- A. RED WIRE - CONNECT TO ACCESSORY +12 VOLTS - 20 AMP CIRCUIT.

**NOTE:** IMPROPER INSTALLATION COULD LEAD TO BATTERY DRAIN IF CONNECTED TO A CONSTANT BATTERY SOURCE.

- B. RED/YELLOW STRIPE WIRE - CONNECT TO IGNITION +12 VOLTS - 5 AMP CIRCUIT.

- C. YELLOW WIRE - CONNECT HEADLIGHT/NIGHT LAMP +12 VOLTS - 5 AMP CIRCUIT.

- D. BLACK WIRE - IT IS RECOMMENDED TO CONNECT THE RING TERMINAL TO THE VEHICLE BODY USING AN EXISTING COMMON GROUND POINT. IF ONE IS NOT ACCESSIBLE, CONNECT TO A GROUND WIRE WITH HIGH CURRENT CAPACITY.

3. CONNECT THE 2-PIN CONNECTORS OF THE ELEMENTS TO THE POWER HARNESS.

**NOTE:** VERIFY THAT ALL CONNECTIONS ARE SECURED AND THE SEAT MOVEMENT WILL NOT INTERFERE WITH HARNESS. BE SURE HARNESS IS FREE FROM SHARP OBJECTS, PINCH POINTS AND MOVING PARTS.

4. SECURE THE RELAY USING THE SUPPLIED WIRE TIES.

5. SECURE HARNESS USING SUPPLIED ZIP TIES. BE SURE HARNESS IS FREE FROM SHARP OBJECTS, PINCH POINTS AND MOVING PARTS.

# INSTALLATION

## E. SWITCH INSTALLATION



1. CHOOSE A SWITCH LOCATION ON A FLAT SURFACE (SEAT PANEL OR CONSOLE PANEL) WHERE SWITCH BODY AND WIRES WON'T INTERFERE WITH SEAT MOVEMENT OR OTHER VEHICLE COMPONENTS.
2. REMOVE THE PANEL FROM THE SEAT OR VEHICLE CONSOLE.

### ROUND SWITCH KIT

- A. MARK THE SWITCH LOCATION, CUT AN OPENING USING A PUNCH TOOL OR DRILL BIT (4/5 IN OR 20MM). **FIGURE 8**
- B. USING A FILE OR SIMILAR TOOL, MAKE A SMALL NOTCH TO EASE THE INSTALLATION AND KEEP THE SWITCH FROM ROTATING. TAKE CARE TO PROPERLY ORIENT THE SWITCH PRIOR TO NOTCHING.

### SINGLE AND DUAL-DIAL SWITCH KIT

- A. USE THE SUPPLIED TEMPLATE (**FIGURE 9**) AND MARK THE SWITCH LOCATION. TAKE CARE TO PROPERLY ORIENT THE SWITCH.
- B. CAREFULLY CUT AN OPENING USING A DRILL CUTTING TOOL OR OTHER SIMILAR CUTTING TOOL. BE SURE TO SQUARE THE CORNERS USING A FILE OR SIMILAR TOOL.

3. INSERT THE SWITCH AND FIRMLY PRESS INTO PLACE. MAKE SURE RETAINING CLIPS SNAP SECURELY.
4. CONNECT THE SWITCH CONNECTOR TO THE MAIN HARNESS CONNECTOR.

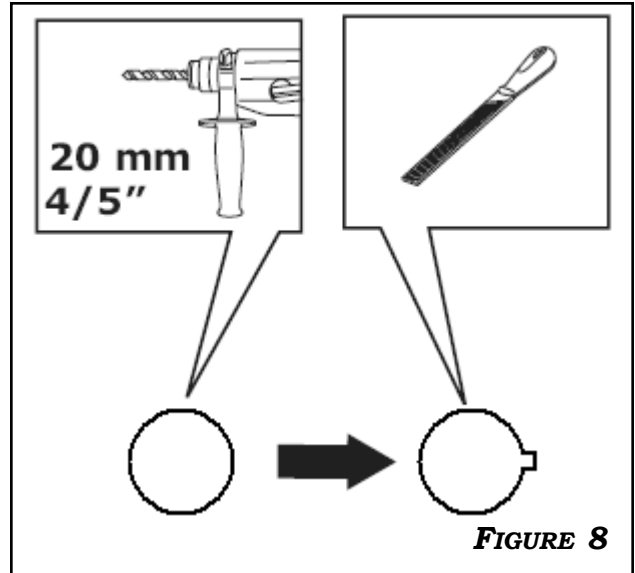

**FIGURE 8**

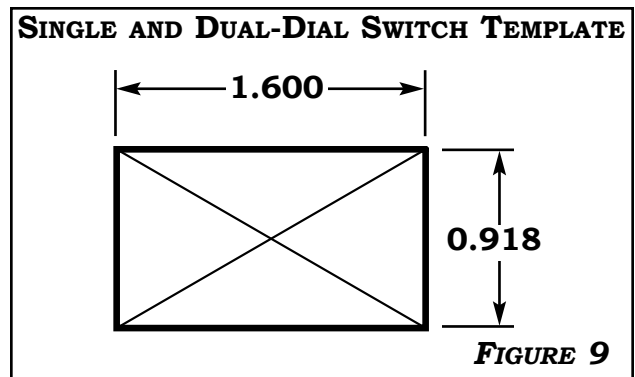

**FIGURE 9**

# INSTALLATION

## F. FINAL ASSEMBLY

1. REASSEMBLE TRIM PIECES AND CONSOLE TAKING CARE TO AVOID DAMAGE TO HARNESES AND CONNECTORS.
2. MAKE SURE VEHICLE FLOOR IS CLEAR AND CAREFULLY PLACE SEAT INTO VEHICLE.
3. ENSURE ALL CONNECTORS UNDER SEAT HAVE BEEN PROPERLY CONNECTED AND SECURED WITH WIRE TIES AND NOTHING WILL BE DAMAGED DURING SEAT MOVEMENT.
4. TORQUE SEAT BOLTS PER SERVICE MANUAL.
5. RECONNECT BATTERY CABLE(S). RE-ENTER ANY THEFT DETERRENT INFORMATION, IF APPLICABLE.
6. RE-CHECK ALL SYSTEMS AND ACCESSORIES WHERE COMPONENTS WERE REMOVED OR RELOCATED DURING THE INSTALLATION PROCESS.

**Note:** IF THE PASSENGER SEAT CUSHION HAS A SEAT OCCUPANT SENSOR FOR AIRBAG DEPLOYMENT, REFER TO THE MANUFACTURER'S VEHICLE MANUAL FOR RECALIBRATION GUIDELINES.

# TROUBLESHOOTING

<p>THE HEATING DOES NOT FUNCTION ALTHOUGH IT IS SWITCHED ON. THE LED IS NOT ILLUMINATED.</p>	<p>CHECK THE FUSE AND CHANGE IF NECESSARY.</p>
<p>THE LED IS NOT ILLUMINATED ALTHOUGH THE HEATING IS FUNCTIONING AND SWITCHED ON.</p>	<p>THE LED IN THE SWITCH IS DEFECTIVE.</p>
<p>THE HEATING DOES NOT FUNCTION ALTHOUGH IT IS SWITCHED ON. THE LED IS ON.</p>	<p>THE TEMPERATURE OF THE SEAT COVER COULD BE TOO HIGH DUE TO HIGH INTERIOR TEMPERATURE. THE THERMOSTAT IN THE SEAT HEATING UNIT IS CONNECTED. WAIT UNTIL THE SEAT COVER'S TEMPERATURE HAS FALLEN AND TRY AGAIN.</p>
<p>THE FUSE BURNS OUT REPEATEDLY.</p>	<p>VERIFY THE FUSE RATING IS CORRECT: ROUND SWITCH/SINGLE-DIAL SWITCH =10 AMPS DUAL-DIAL SWITCH =15 AMPS</p>

## SAFETY ADVICE/WARNINGS

**WARNING:** THE SEAT HEATING UNIT IS ONLY ALLOWED TO BE OPERATED WHEN A PERSON IS SITTING ON IT. THIS PERSON MUST FEEL TEMPERATURES AND BE ABLE TO REACT TO THEM. PERSONS WHO EXPERIENCE DIFFICULTY WITH FEELING TEMPERATURES – SUCH AS PARAPLEGIC PERSONS, CHILDREN AND ELDERLY PEOPLE – ARE NOT ALLOWED TO USE THE SEAT HEATING UNIT BECAUSE THERE IS A RISK THAT THEY WILL SUFFER INJURY FROM BURNS. THE SEAT HEATING UNIT, LIKE ANY OTHER HEATING APPLIANCE, SHOULD NOT BE SWITCHED ON AND LEFT UNSUPERVISED. UNINTENTIONAL ACTIVATION OF THE SEAT HEATING UNIT SHOULD BE AVOIDED.

- \* IF THE SEAT OCCUPANT FEELS AN EXCESSIVE TEMPERATURE AFTER THE SEAT HEATING UNIT HAS BEEN SWITCHED ON, CHANGE TO LOWER SETTINGS TO REDUCE HEAT OR SWITCH OFF COMPLETELY.
- \* THE SEAT HEATING ELEMENT IS NOT ALLOWED TO COME INTO CONTACT WITH KNIVES, NAILS, NEEDLES, TOOLS OR ANY MATERIAL THAT COULD PENETRATE AND PIERCE THE SEAT'S SURFACE OR THE HEATING ELEMENTS.
- \* THE 'HIGH' SETTING IS UNSUITABLE FOR CONTINUOUS OPERATION.
- \* THE SEAT HEATING UNIT MUST BE SWITCHED OFF AFTER THE ENGINE HAS BEEN SWITCHED OFF IF THE INSTALLATION IS POWERED VIA THE CONTINUOUS DUTY PLUS CIRCUIT, IN ORDER TO AVOID DISCHARGING THE BATTERY.
- \* SHARP OBJECTS ARE NOT ALLOWED TO BE LAYED ON OR TRANSPORTED IN THE SEAT. EXCESSIVE WEIGHTS OR HEAVY OBJECTS THAT ARE PUT DOWN ON THE SEAT CAN CAUSE DAMAGE TO THE SEAT HEATING UNIT AND AFFECT ITS OPERATION ADVERSELY. IT IS THEREFORE RECOMMENDED NOT TO PUT OBJECTS ON THE SEAT.
- \* IF IT IS NOTICED THAT AN UNUSUAL SMELL DEVELOPS WHEN THE SEAT HEATING UNIT IS SWITCHED ON OR IF THERE IS AN UNEVEN DISTRIBUTION OF HEAT ON THE SEAT OR BACKREST – OR BETWEEN THE SEAT AND BACKREST AS THE CASE MAY BE – THEN THE SEAT HEATING UNIT MUST BE SWITCHED OFF IMMEDIATELY AND THE SPECIALIZED WORKSHOP MUST BE CONTACTED. THE SEAT HEATING UNIT IS ONLY ALLOWED TO BE MODIFIED OR DECOMMISSIONED BY A SPECIALIZED WORKSHOP.
- \* THE SEAT IS NOT ALLOWED TO BE COVERED WITH INSULATING MATERIALS (INCLUDING BLANKETS OR RUGS, JACKETS, CUSHIONS, BAGS, HANDBAGS, RETRO-FITTED SEAT MATS, CHILDREN'S SEATS, SEAT REINFORCEMENT, PROTECTIVE COVERS, ETC.) WHENEVER THE SEAT HEATING UNIT HAS BEEN SWITCHED ON. THE SEAT HEATING UNIT'S FUNCTION COULD BE AFFECTED IF IT IS OPERATED WHEN THESE MATERIALS ARE PRESENT: THIS COULD RISK DAMAGE TO THE SEAT OR BURNING INJURIES TO SEAT OCCUPANT.
- \* THE SEAT HEATING UNIT IS NOT ALLOWED TO BE EXPOSED TO EXCESSIVE MOISTURE. SMALL AMOUNTS OF THE FOLLOWING LIQUIDS DO NOT ADVERSELY AFFECT THE SEAT HEATING UNIT FROM BEING OPERATED SAFELY AND CONTINUOUSLY AFTER IT HAS COMPLETELY DRIED: PERSPIRATION, BEVERAGES (E.G., COFFEE, COLA, MINERAL WATER, ETC.), BRINE (5 % IN SOLUTION), CLEANING AGENTS CONTAINING AMMONIA (10 % BY VOLUME), CLEANING AGENTS CONTAINING ALCOHOL (10 % BY VOLUME), CLEANING AGENTS FOR PLASTIC OR VINYL, AS WELL AS SOAPY WATER.

**WARNING:** EXCESSIVE CONTACT WITH ANY LIQUIDS CAN ADVERSITY AFFECT THE PERFORMANCE OF THE SEAT HEATING UNIT AND CAUSE ITS SERVICE LIFE TO BE REDUCED. THE SEAT HEATING ELEMENT MUST NOT BE TURNED ON AT ANY TIME WHEN EXCESSIVE MOISTURE HAS DAMPENED THE SEAT SURFACE OR INTERNAL COMPONENTS, OR BOTH. THE SEAT HEATING ELEMENT MUST NOT BE OPERATED, WHEN ARTICLES OF CLOTHING ARE WET OR MOIST. THE SEAT HEATING ELEMENT IS UNSUITABLE FOR DRYING DAMP/WET CLOTHING OR OBJECTS.