



# ROSTRA STUDENT DETECTION SYSTEM

**250-7201**



**READ INSTALLATION MANUAL PRIOR TO INSTALLATION**

## CONTENTS

INTRODUCTION.....	2
PARTS LIST.....	3
PARTS DIAGRAM.....	4
CONNECTION SCHEMATIC .....	5
SYSTEM LAYOUT .....	6
INSTALLATION OVERVIEW.....	7
HELPFUL HINTS.....	8
INSTALLATION .....	9
SYSTEM CONFIGURATION PROGRAMMING.....	15
SYSTEM TESTING.....	17

# INTRODUCTION

## SYSTEM DESCRIPTION

THE ROSTRA SDS™ (STUDENT DETECTION SYSTEM) IS DESIGNED TO ALERT THE SCHOOL BUS DRIVER TO THE PRESENCE OF STUDENTS AND OTHER MOVING OBSTACLES WITHIN UP TO 5 DANGER ZONES. THE DANGER ZONES ARE IDENTIFIED AS ZONE 1 (FRONT), ZONE 2 (FRONT TIRES), ZONE 3 (REAR TIRES), ZONE 4 (REARSENTRY™ OR REAR BUMPER), AND ZONE 5 (EXIT SIDE WALL). SEE **DIAGRAM 1**. THE SDS™ IS A MOTION ACTIVATED SYSTEM THAT USES 7 OR 10 MICROWAVE RADAR SENSORS TO DETECT OBSTACLES AROUND THE BUS. WHEN AN OBSTACLE IS DETECTED IN ANY OF THE SPECIFIED DANGER ZONES, AN ALARM WILL SOUND TO ALERT THE DRIVER. THE ALARM WILL BE ACCOMPANIED BY FLASHING LEDs ON A DRIVER DISPLAY THAT CORRESPOND TO EACH SENSOR IN THE FIVE ZONES. THIS ALLOWS THE DRIVER TO QUICKLY PINPOINT THE AFFECTED ZONE AND TAKE ACTION.

MOST ZONES OF THE SDS™ SYSTEM ARE ACTIVATED BY THE ACTIVATION OF THE STOP SIGN OR STATE LIGHTS. THE REARSENTRY™ OR BACK-UP SENSOR ZONE IS ACTIVE ONLY WHEN THE BUS IS PUT IN REVERSE GEAR. ADDITIONALLY, SOME BUSES ARE EQUIPPED WITH A CROSSING GATE CANCEL SWITCH THAT ALLOWS THE CROSSING GATE TO BE RETRACTED INDEPENDENTLY OF THE STATE LIGHTS. THIS IS USED IN STATES WHERE BUSES ARE REQUIRED TO HAVE THEIR STATE LIGHTS ACTIVE DURING LOADING AND UNLOADING AT THE SCHOOL. IN THIS SITUATION AT THE SCHOOL, IT IS PROBABLE THAT STUDENTS MAY CONGREGATE NEAR THE BUS AND SET OFF THE ALARMS. THE SDS™ CAN INTERFACE WITH THIS SWITCH SO THAT WHEN IT'S DEPRESSED, THE VOLUME OF THE AUDIBLE ALERTS WILL BE SIGNIFICANTLY REDUCED. THE SYSTEM ALSO REQUIRES IGNITION AND GROUND INPUTS.

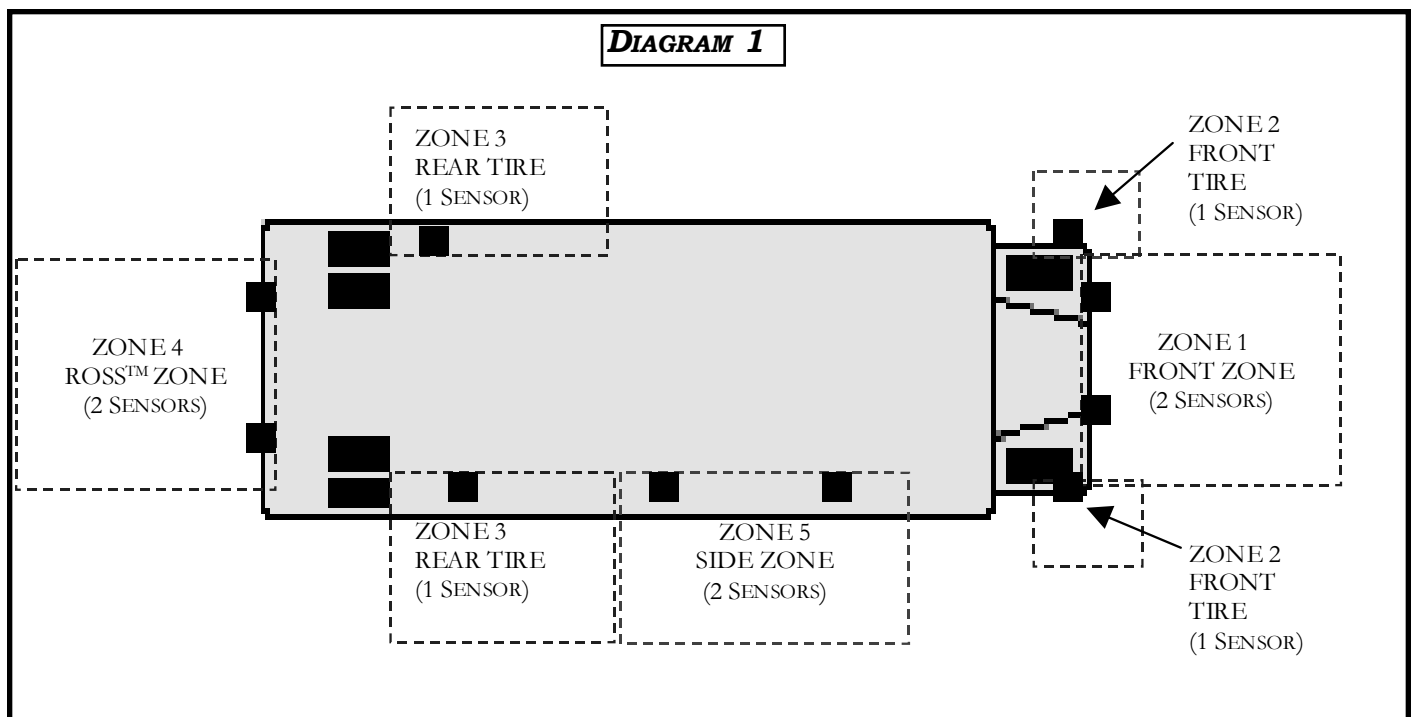

# ***PARTS LIST***

<b>ITEM*</b>	<b>QUANTITY</b>	<b>PART NUMBER</b>	<b>DESCRIPTION</b>
1	5	250-2577	CONTROLLER ASSEMBLY
2	10	250-2578	SENSOR ASSEMBLY
3	8	250-2579	SENSOR TOP BRACKET
4	4	250-2580	SENSOR SIDEWALL MOUNTING BRACKET
5	2	250-2581	SENSOR CORNER MOUNTING BRACKET
6	1	250-2582	DRIVER DISPLAY MODULE
7	1	250-2583	DISPLAY MODULE MOUNTING BRACKET TYPE 1
8	1	250-2584	DISPLAY MODULE MOUNTING BRACKET TYPE 2
9	1	250-2585	BUS INTERFACE HARNESS
10	4	250-2586	6'CONTROLLER MODULE EXTENSION HARNESS
11	6	250-2521	3'SENSOR EXTENSION HARNESS
12	4	250-4360	8'SENSOR EXTENSION HARNESS
13	1	250-2587	MAIN CONTROLLER TRUNK HARNESS
14	1	250-2590	HARDWARE PACKAGE
15	1	250-2591	FUSE HARNESS

**\*SEE PAGE 4**

# PARTS DIAGRAM

DIAGRAM 2

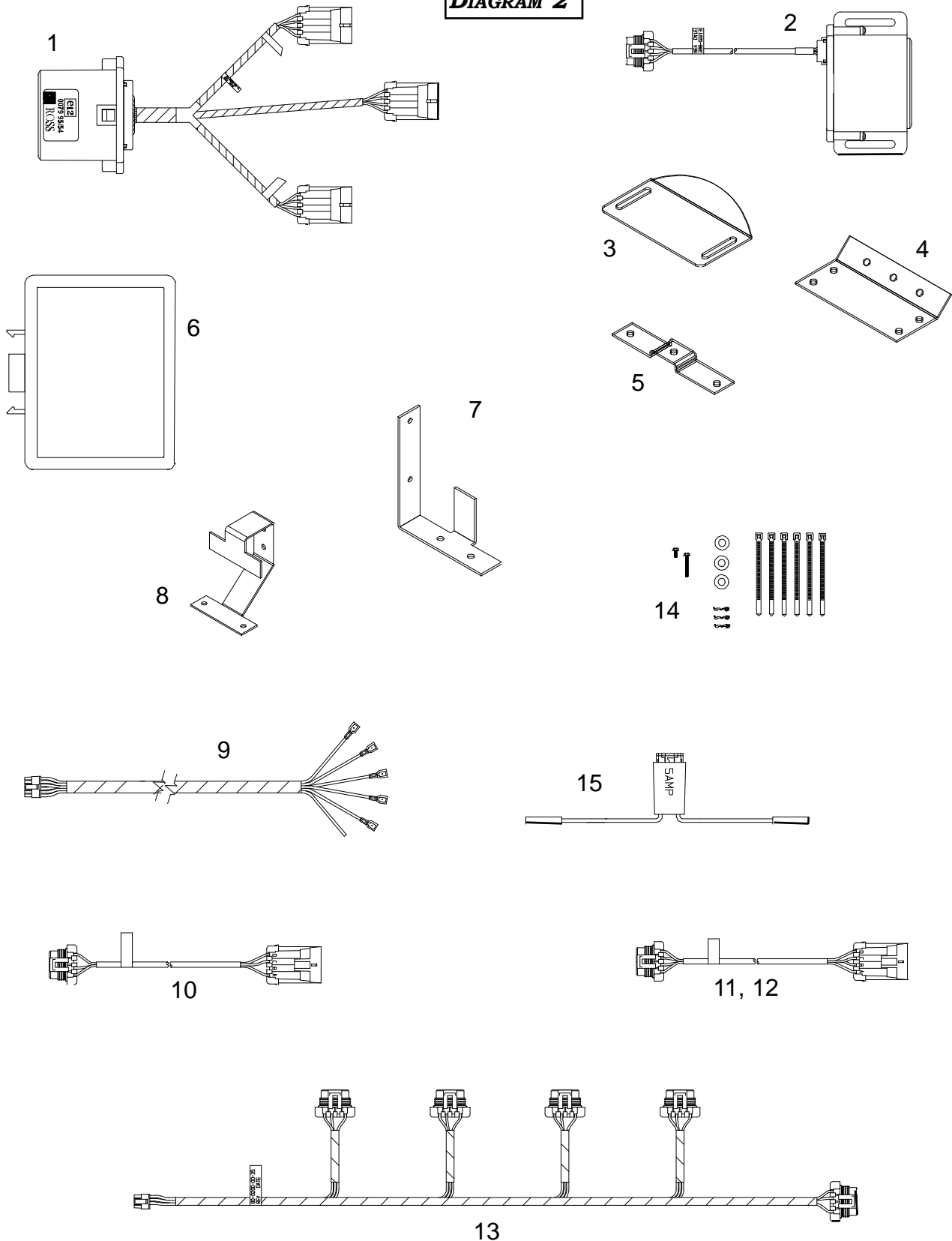

# CONNECTION SCHEMATIC

**DIAGRAM 3**

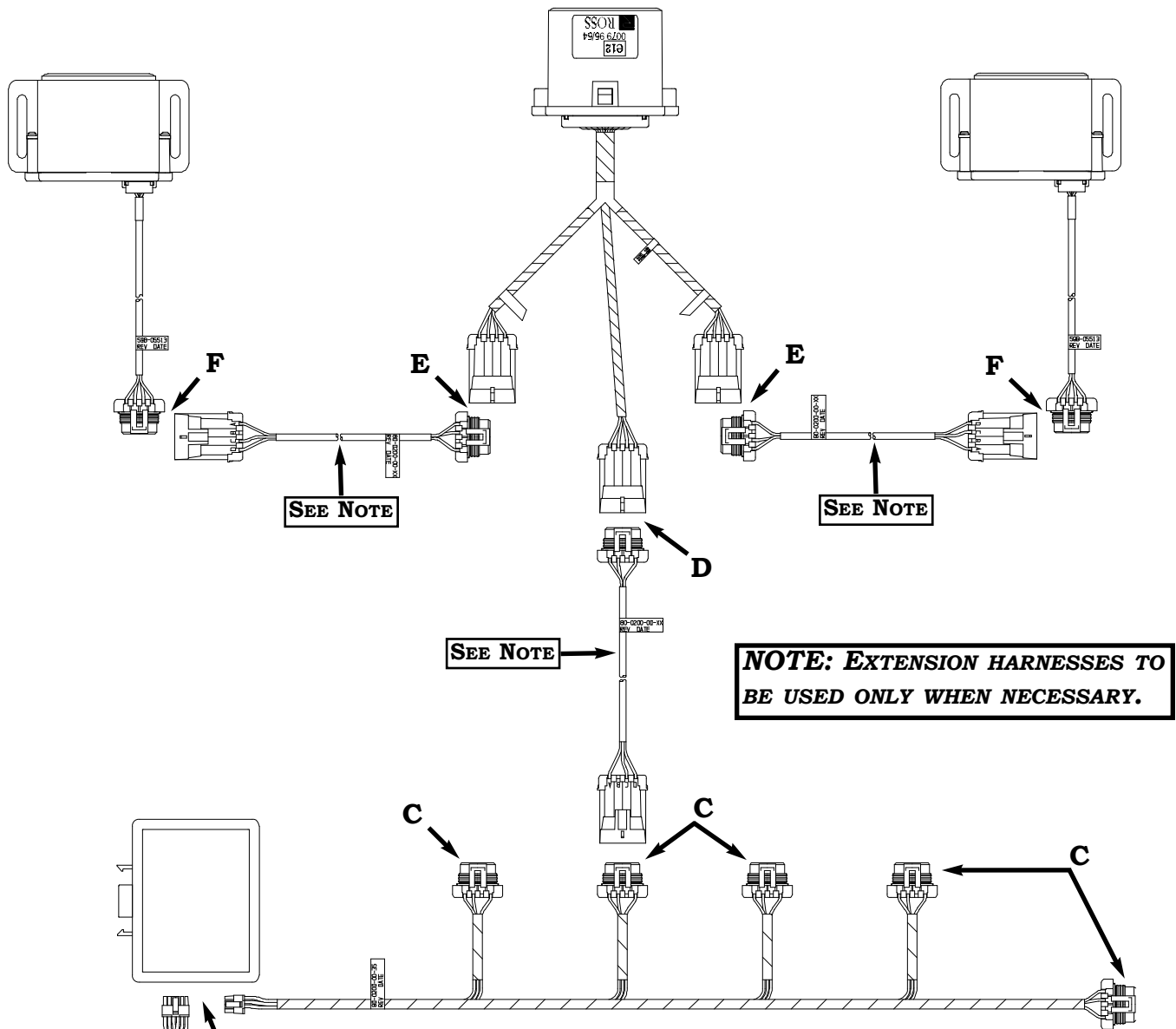

## SCHEMATIC DESCRIPTION

- A. BUS INTERFACE HARNESS (BIH): POWER, GROUND, REVERSE, STOP SIGN, CROSSING GATE CANCEL (OPTIONAL)
- B. CONNECT BUS INTERFACE HARNESS AND MAIN CONTROLLER TRUNK (MCT) HARNESS TO THE DRIVER DISPLAY.
- C. CONNECT THE TRUNK HARNESS TO ONE OF THE (5) CONTROL MODULE EXTENSION HARNESSSES. THIS IS DONE FOR EACH OF THE (5) CONTROLLERS ON THE BUS.
- D. CONNECT EXTENSION HARNESS TO A CONTROL MODULE.
- E. CONNECT A 3 OR 8 FOOT SENSOR EXTENSION HARNESS TO CONTROL MODULE.
- F. CONNECT THE SENSORS (10) TO THE SENSOR EXTENSION HARNESSSES.

# SYSTEM LAYOUT

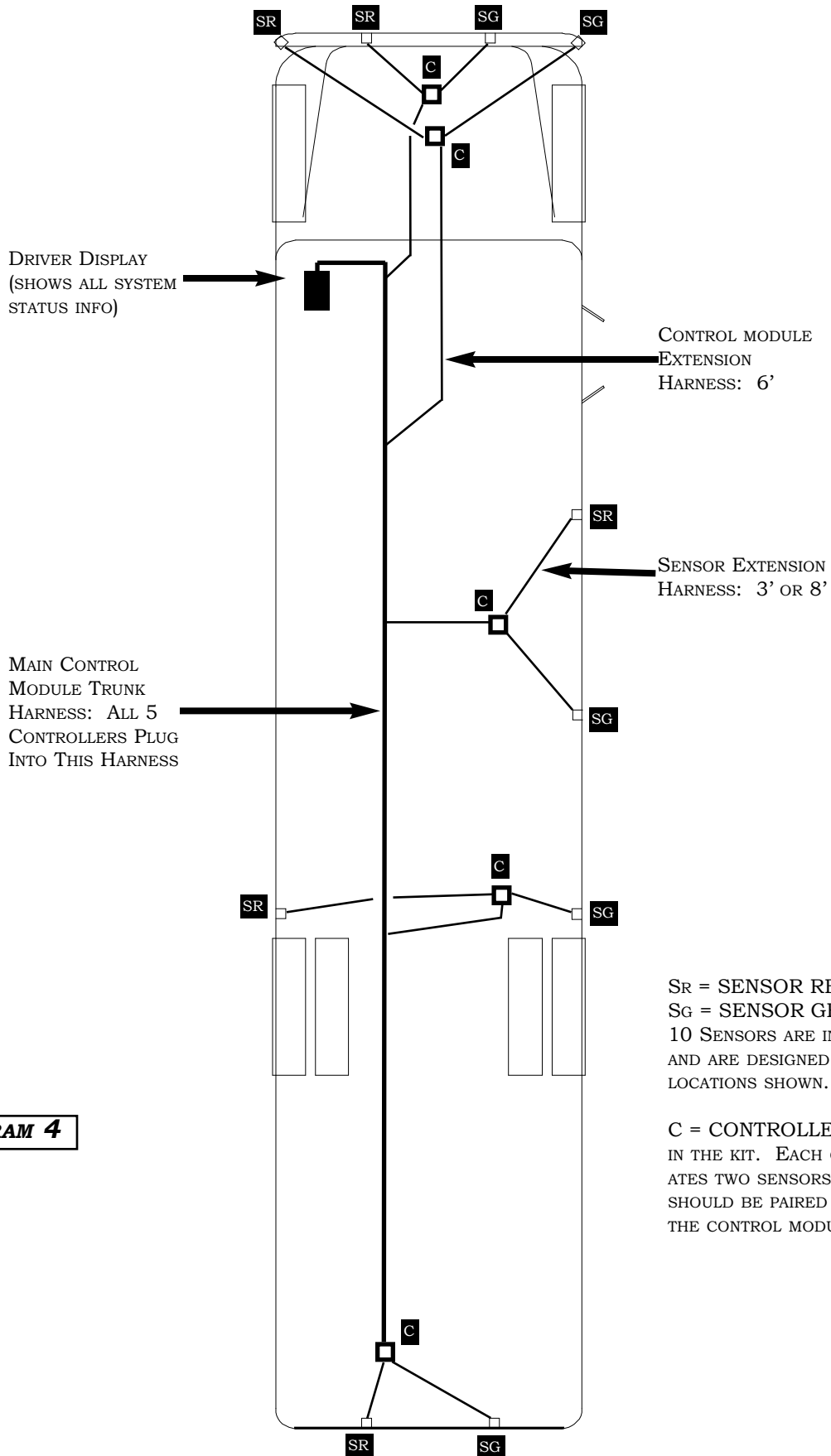

DRIVER DISPLAY  
(SHOWS ALL SYSTEM  
STATUS INFO)

CONTROL MODULE  
EXTENSION  
HARNESS: 6'

SENSOR EXTENSION  
HARNESS: 3' OR 8'

MAIN CONTROL  
MODULE TRUNK  
HARNESS: ALL 5  
CONTROLLERS PLUG  
INTO THIS HARNESS

SR = SENSOR RED  
SG = SENSOR GREEN  
10 SENSORS ARE INCLUDED IN THIS KIT  
AND ARE DESIGNED TO MOUNT IN THE  
LOCATIONS SHOWN.

C = CONTROLLER: 5 ARE INCLUDED  
IN THE KIT. EACH CONTROLLER OPER-  
ATES TWO SENSORS. THE SENSORS  
SHOULD BE PAIRED AND CONNECTED TO  
THE CONTROL MODULES AS SHOWN.

**DIAGRAM 4**

# INSTALLATION OVERVIEW

**BEFORE BEGINNING THE INSTALLATION READ THIS ENTIRE INSTALLATION MANUAL FIRST.**

**IMPORTANT! IF THE SENSOR'S WIRE HARNESS IS MARKED WITH YELLOW TAPE, THIS SENSOR CAN ONLY BE USED WITH A CONTROLLER THAT ALSO HAS YELLOW TAPE ON ITS HARNESS.**

**TO INSTALL THE SDS™, USE THE FOLLOWING STEPS:**

- STEP 1:** COMPONENT IDENTIFICATION
- STEP 2:** MAKE ELECTRICAL CONNECTIONS AND MOUNT DRIVER DISPLAY
- STEP 3:** MOUNT ZONE 1 SENSORS AND CONTROLLER
- STEP 4:** MOUNT ZONE 2 SENSORS AND CONTROLLER
- STEP 5:** MOUNT ZONES 3 AND 5 SENSORS AND CONTROLLERS
- STEP 6:** MOUNT ZONE 4 SENSORS AND CONTROLLER
- STEP 7:** SYSTEM CONFIGURATION PROGRAMMING
- STEP 8:** SYSTEM TESTING

## **COMPONENT IDENTIFICATION**

INCLUDES UNPACKING AND SEPARATING THE VARIOUS COMPONENTS ACCORDING TO FUNCTION.

## **DISPLAY MOUNTING/ELECTRICAL CONNECTIONS**

THIS INVOLVES MOUNTING THE DRIVER DISPLAY SOMEWHERE ON THE DASH IN PLAIN VIEW OF THE DRIVER. BUT NOT TO INTERFERE WITH THE DRIVER'S LINE OF VISION THROUGH THE WINDSHIELD. THIS STEP ALSO INCLUDES CONNECTING THE BUS INTERFACE HARNESS (BIH) TO THE BUS' IGNITION, CHASSIS GROUND, STOP SIGN OR STATE LIGHTS, REVERSE LIGHTS, AND CROSSING GATE CANCEL RELAY (IF SO EQUIPPED). ADDITIONALLY, THE MAIN CONTROLLER TRUNK HARNESS (MCT) WILL BE INSTALLED AT THIS TIME. THIS IS THE LONGEST HARNESS IN THE KIT AND PERFORMS THE FUNCTION OF CONNECTING THE FIVE CONTROLLERS THROUGHOUT THE BUS TO THE DRIVER DISPLAY.

## **ZONES 1-5 SENSOR AND CONTROLLER MOUNTING**

THIS CATEGORY IS ESSENTIALLY IDENTICAL FOR EVERY ZONE OF THE BUS. ASIDE FROM MINOR DIFFERENCES IN PLACEMENT AND BRACKETRY, ALL TEN SENSORS WILL MOUNT THE SAME WAY, AS WILL ALL FIVE CONTROLLERS. ONCE THE SENSORS ARE PLACED IN THE RECOMMENDED LOCATIONS, THEIR CORRESPONDING CONTROLLERS ARE MOUNTED IN CLOSE PROXIMITY. THEN THE SENSORS ARE CONNECTED TO THEIR CONTROLLERS AND THE CONTROLLERS ARE CONNECTED TO THE MCT VIA HEAVY-DUTY CABLES OF VARIOUS LENGTHS.

## **SYSTEM CONFIGURATION PROGRAMMING**

THIS IS WHEN THE DRIVER DISPLAY MODULE IS PROGRAMMED AND SET-UP FOR THE TYPE OF BUS THAT THE SDS SYSTEM IS INSTALLED ON. ONE BUTTON ON THE DISPLAY SERVES AS THE INTERFACE FOR PROGRAMMING. FOLLOWING INSTRUCTIONS LAID OUT IN THIS INSTALLATION MANUAL, THE INSTALLER WILL PROGRAM A CONFIGURATION FOR THE SYSTEM.

## **TESTING**

THE SYSTEM SHOULD BE TESTED TO ENSURE ALL SENSORS IN ALL ZONES ARE FULLY OPERATIONAL AND PERFORM AS DESIGNED.

# HELPFUL HINTS

## 1. BEFORE STARTING INSTALLATION:

FAMILIARIZE YOURSELF WITH THE INSTALLATION INSTRUCTIONS AND SDS™ SYSTEM COMPONENTS. YOU WILL NEED VARIOUS AUTOMOTIVE TOOLS INCLUDING A DRILL WITH 1/4" BITS, 10MM SOCKETS AND WRENCHES, AND WIRE CUTTERS TO COMPLETE THE INSTALLATION.

## 2. MATING HARNESES:

- A. WHEN DISCONNECTING HARNESES, HOLD CONNECTOR AND PULL THE LOCK UPWARD WHILE PULLING HARNESES APART. **FIGURE 1**
- B. WHEN CONNECTING MATING HARNESES, PUSH MALE 4-PIN CONNECTOR (BLACK) INTO FEMALE 4-PIN CONNECTOR (GRAY) UNTIL LOCKING MECHANISMS ARE FIRMLY LOCKED TOGETHER. **FIGURE 2**

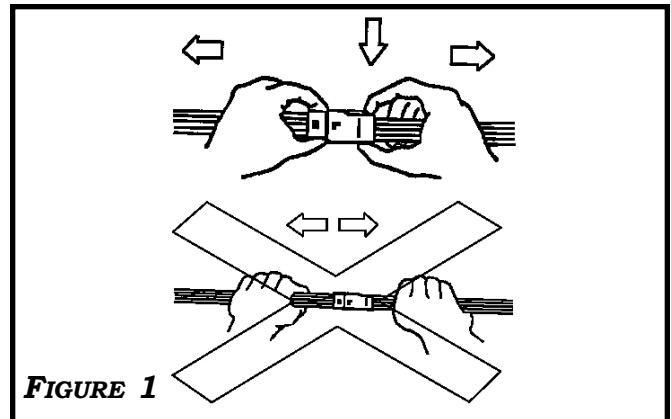

**FIGURE 1**

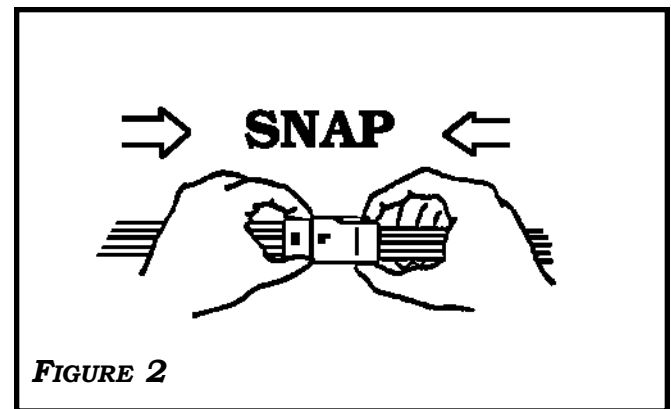

**FIGURE 2**

## 3. FEMALE T-TAP CONNECTOR:

WHEN INSTALLING FEMALE **T-TAP CONNECTORS**, ENSURE WIRE IS INSIDE GROOVE OF THE FEMALE **T-TAP CONNECTOR** BEFORE CLOSING ON WIRE WITH PLIERS. **FIGURE 3**

## 4. STRAIN RELIEF:

APPLY A **TIE STRAP** ANCHORING THE HARNESS AS CLOSE TO THE SENSOR AS POSSIBLE AS NOT TO HAVE TENSION AT HARNESS EXIT FROM SENSOR. THIS WILL ALSO MINIMIZE VIBRATION SENSED DURING OPERATION. **FIGURE 4**

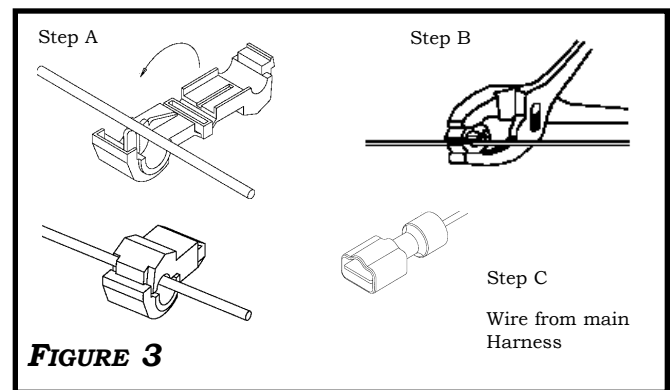

**FIGURE 3**

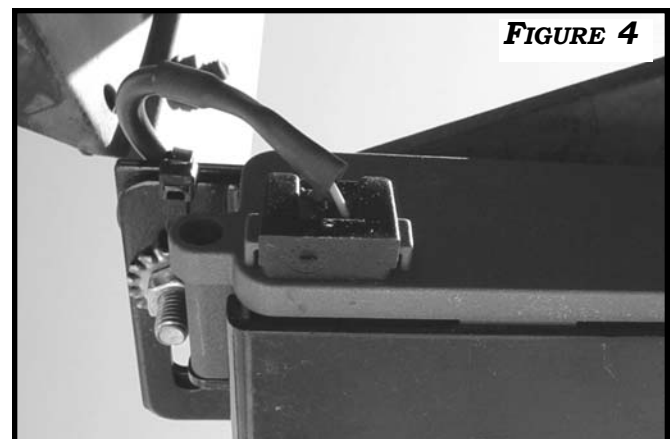

**FIGURE 4**



# INSTALLATION

## STEP 1: COMPONENT IDENTIFICATION

UNPACK THE SDS SHIPPING CARTON AND SEPARATE LIKE COMPONENTS. USE THE **PARTS LIST** AND **PARTS DIAGRAM** ON **PAGES 3-4** FOR REFERENCE THROUGHOUT THE INSTALLATION PROCESS.

## STEP 2: ELECTRICAL CONNECTIONS AND DRIVER DISPLAY MOUNTING

1. LOCATE THE BUS' MAIN ELECTRICAL PANEL. THIS CAN BE IN THE DRIVER'S AREA OR ON THE OUTSIDE WALL OF THE BUS. **FIGURES 5-6**
2. CONNECT THE RED MALE SPADE TERMINALS OF THE SDS™ BUS INTERFACE HARNESS (BIH) TO THE BUS' ELECTRICAL PANEL USING THE SUPPLIED RED T-TAP CONNECTORS AND FOLLOWING THIS WIRING CHART:

BIH WIRE COLOR	BUS EXISTING WIRE
RED*	IGNITION
BLACK	CHASSIS GROUND
WHITE	STOP SIGN
BLUE	REVERSE LIGHTS
YELLOW	CROSSING GATE OVERRIDE RELAY (OPTIONAL)

*\*THE SUPPLIED FUSE HARNESS SHOULD BE SPLICED INTO THE RED IGNITION LEAD OF THE BIH.*

3. ONCE THE ELECTRICAL CONNECTIONS ARE MADE, ROUTE THE BIH TO AN APPROPRIATE AREA FOR MOUNTING THE DRIVER DISPLAY. POSSIBLE LOCATIONS INCLUDE ANY VACANT AREA NEAR THE PANEL OR ABOVE OR BELOW THE DASHBOARD.

**CAUTION:** DO NOT MOUNT THE DISPLAY IN SUCH A WAY THAT IT INTERFERES WITH THE DRIVER'S LINE OF SIGHT TO THE MIRRORS OR WINDSHIELD.

4. MOUNT THE DRIVER DISPLAY TO THE CHOSEN AREA USING ONE OF THE SUPPLIED DISPLAY BRACKETS IF NECESSARY. THE DISPLAY IN **FIGURE 7** WAS MOUNTED DIRECTLY TO THE SIDE PANEL WITHOUT A BRACKET. IN THIS CASE ENLARGE THE HOLES ON THE QUICK RELEASE CLIP TO 1/4" AND USE

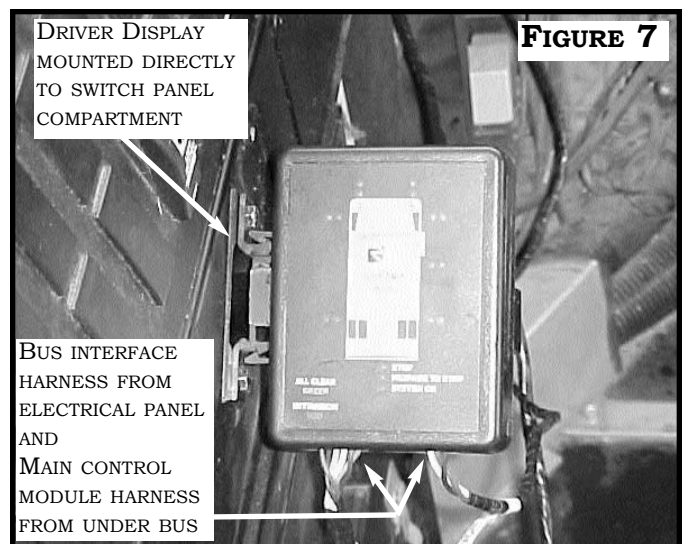
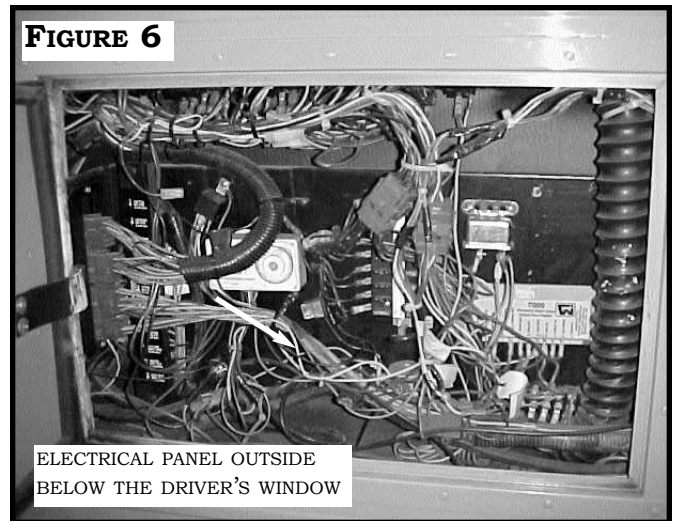
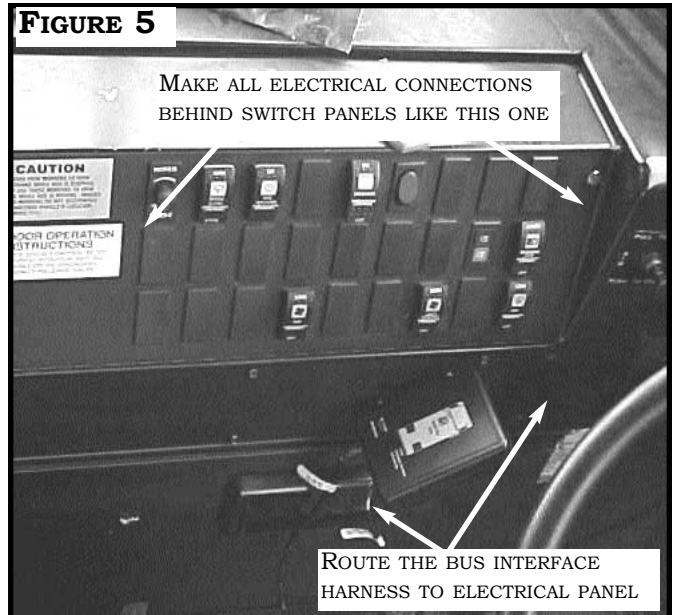

# INSTALLATION

## STEP 2: DRIVER DISPLAY MOUNTING AND WIRE ROUTING (CONTINUED)

THE SUPPLIED 20MM BOLTS TO MOUNT IT. IF A BRACKET IS BEING USED, MOUNT THE QUICK RELEASE CLIP TO THE BRACKET USING THE BLACK 12MM SCREWS AND LOCK NUTS. THEN MOUNT THE DISPLAY BRACKET TO THE BUS USING THE 20MM BOLTS AND NUTS/WASHERS AS REQUIRED.

5. FIND AN ENTRY POINT TO ALLOW THE MAIN CONTROLLER TRUNK HARNESS (MCT) TO PASS FROM THE FRAME UNDER THE BUS TO THE DRIVER DISPLAY. FOR CONVENTIONAL IC BUSES THIS CAN BE A GROMMET IN THE ENGINE COMPARTMENT NEAR THE STEERING COLUMN AS IN **FIGURE 8**. FOR FLAT-NOSED TRANSIT STYLE BUSES, HOLES MAY NEED TO BE DRILLED FOR ACCESS. ROUTE THE MCT HARNESS INSIDE THE CAB OF THE BUS TO THE MOUNTED DRIVER DISPLAY. SECURE THE HARNESS WITH WIRE TIES MAKING SURE TO PROVIDE STRESS RELIEF WHERE APPROPRIATE. REFER TO **DIAGRAMS 3 AND 4** FOR THE CONNECTION ILLUSTRATIONS. ROUTE THE REMAINING LENGTH OF THE MCT HARNESS ALONG THE FRAME UNDER THE BUS AS SHOWN IN **FIGURES 9-10**. AT THE END OF THE HARNESS IS THE CONNECTOR FOR THE ROSS™ ZONE CONTROLLER. THIS SHOULD REACH TO WITHIN 6 FEET OF THE REAR BUMPER.



**FIGURE 8**

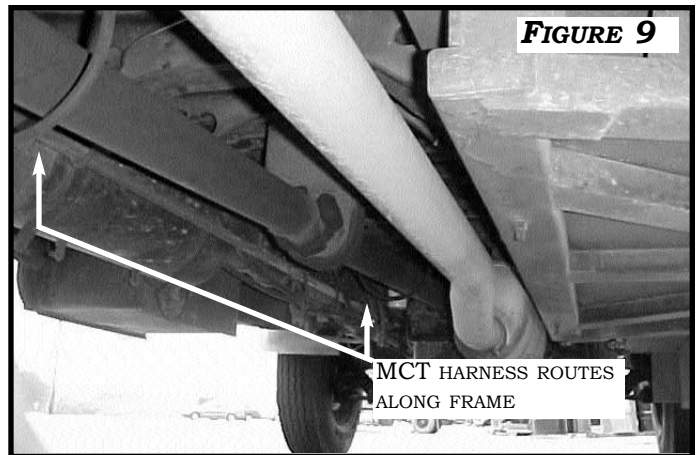

**FIGURE 9**

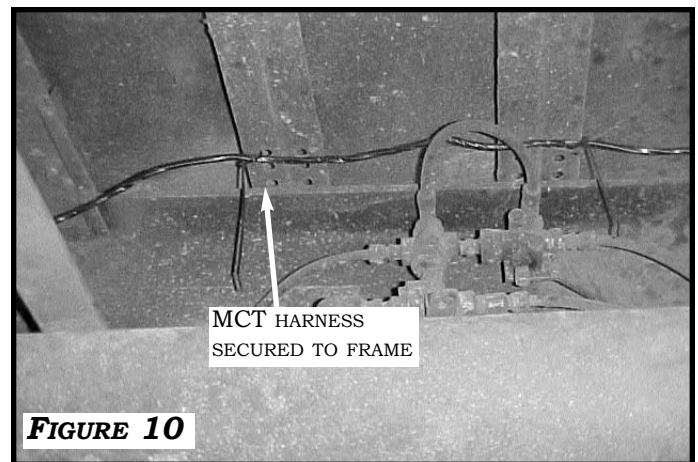

**FIGURE 10**

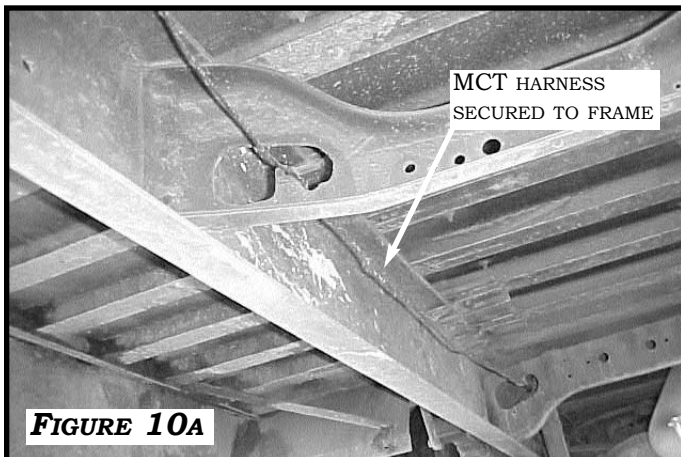
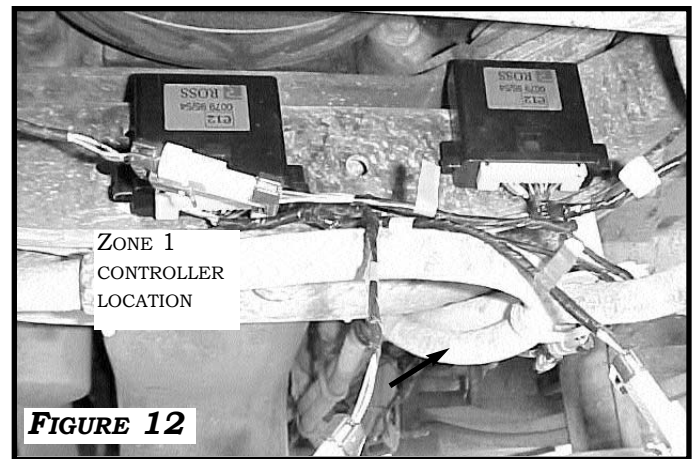
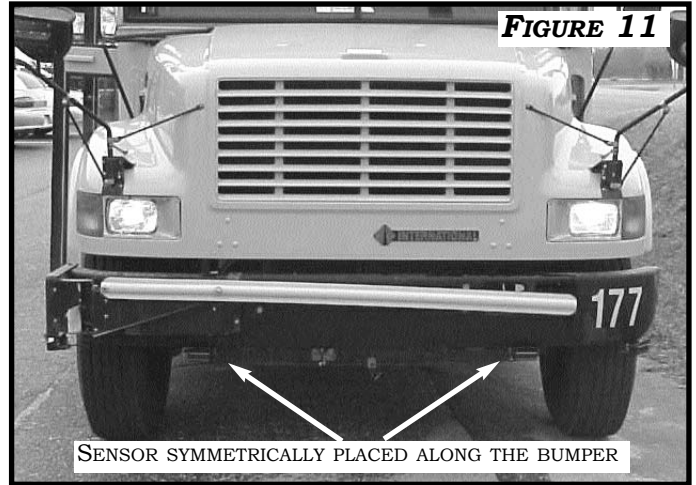

**FIGURE 10A**

# INSTALLATION

## STEP 3: ZONE 1 SENSOR AND CONTROLLER MOUNTING

1. ZONE 1 IS THE AREA OF THE BUS COVERED BY THE TWO MIDDLE SENSORS ON THE FRONT BUMPER OF THE BUS. REFER TO **DIAGRAMS 1 AND 4** FOR SENSOR LOCATIONS. EACH SENSOR SHOULD BE PLACED AT APPROXIMATELY ONE-THIRD TO ONE-FOURTH THE LENGTH OF THE BUMPER FROM EACH END AS SHOWN IN **FIGURE 11**. LINE UP THE SENSOR WITH THE BOTTOM EDGE OF THE BUMPER AND DRILL ONE 1/4" HOLE PER SLOT OF THE SENSOR BRACKET INTO THE BUMPER. THEN PLACE THE TOP PLATE SENSOR BRACKET ONTO THE SENSOR BY LINING UP THE TWO MOUNTING SLOTS. MOUNT THE SENSOR WITH TOP AND BOTTOM BRACKETS ALIGNED TO THE BUMPER USING THE 20MM BOLTS, WASHERS, AND 10MM NUTS SUPPLIED IN THE HARDWARE KIT. **FIGURE 13**.
2. THE CONTROLLER MODULE SHOULD MOUNT IN ANY AVAILABLE AREA IN CLOSE PROXIMITY TO THE ZONE 1 SENSORS. IT CAN BE PLACED ON A FRAME CROSSMEMBER OR BUMPER SUPPORT. MOUNT THE CONTROLLER USING THE 35MM BOLTS SUPPLIED IN THE KIT. **FIGURE 12**
3. CONNECT THE SENSORS TO THE CONTROLLER VIA THE BLACK 3 FOOT SENSOR EXTENSION HARNESSES. CONNECT THE CONTROLLER TO THE MCT HARNESS VIA THE 6 FOOT CONTROLLER EXTENSION HARNESS.\*\* REFER TO **DIAGRAM 3** FOR CONNECTION DESCRIPTION. SECURE ALL HARNESSES WITH WIRE TIES.



**NOTE:** WHILE ALL OF THE MODULES AND HARNESSES IN THE SDS™ SYSTEM ARE DESIGNED TO WITHSTAND THE INDUSTRY STANDARDS FOR HEAT, IT IS NOT RECOMMENDED TO MOUNT CONTROLLERS NEAR THE ENGINE OR EXHAUST MANIFOLDS.

\*\*SEE PAGE 15

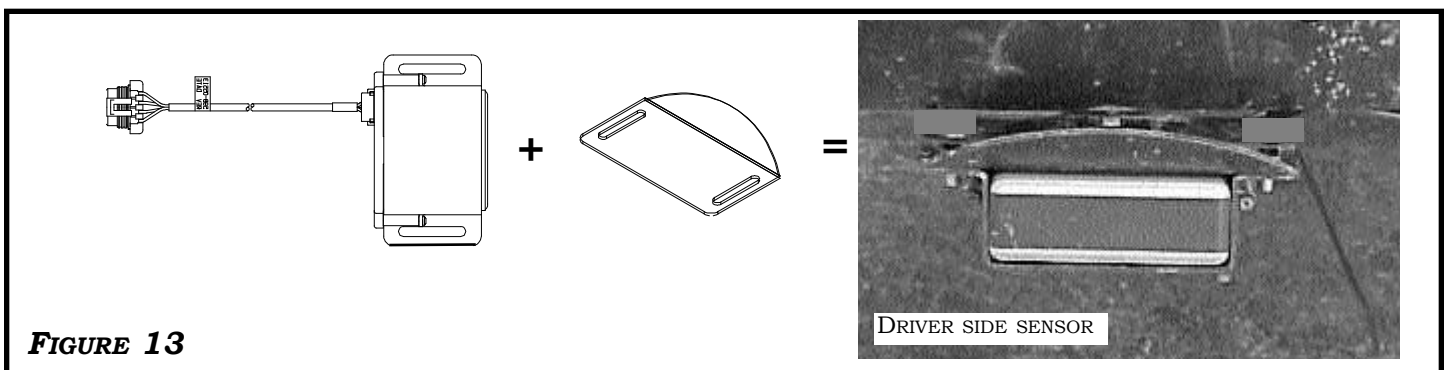

# INSTALLATION

## STEP 4: ZONE 2 SENSORS AND CONTROLLER MOUNTING

1. ZONE 2 IS THE AREA OF THE BUS COVERED BY EACH SENSOR ON THE CORNERS OF THE FRONT BUMPER OF THE BUS. REFER TO **DIAGRAMS 1 AND 4** FOR SENSOR LOCATIONS. EACH SENSOR SHOULD BE ANGLED OUT 60 DEGREES TOWARDS THE FRONT CORNERS. **FIGURE 14** FIND A REASONABLY FLAT SPOT ALONG THE BOTTOM EDGE OF THE LEFT AND RIGHT CORNERS OF THE BUMPER AND DRILL ONE 1/4" HOLE PER SIDE. PLACE THE TOP PLATE SENSOR BRACKET ONTO THE SENSOR ASSEMBLY BY LINING UP THE TWO MOUNTING SLOTS. THEN PLACE THE CENTER BOLT ADAPTER BRACKET ONTO THE TOP PLATE BRACKET BY LINING UP THE HOLES AND SLOTS (**FIGURE 16**). SECURE THE ASSEMBLY OF BRACKETS USING THE 20MM BOLTS, WASHERS, AND 10MM NUTS IN THE KIT. MOUNT THE SENSOR ASSEMBLY TO THE 1/4" HOLE IN THE BUMPER USING ANOTHER 20MM BOLT **FIGURE 16**.
2. THE CONTROLLER MODULE SHOULD MOUNT IN ANY AVAILABLE AREA IN CLOSE PROXIMITY TO THE ZONE 2 SENSORS. IT CAN PLACED ON A FRAME CROSSMEMBER OR BUMPER SUPPORT. MOUNT THE CONTROLLER USING THE 35MM BOLTS SUPPLIED IN THE KIT. **FIGURE 15**
3. CONNECT THE SENSORS TO THE CONTROLLER VIA THE 3 FOOT SENSOR EXTENSION HARNESSSES. CONNECT THE CONTROLLER TO THE MCT HARNESS VIA THE 6 FOOT CONTROLLER EXTENSION HARNESS. \*\* REFER TO **DIAGRAM 3** FOR CONNECTION DESCRIPTION. SECURE ALL HARNESSSES WITH WIRE TIES.

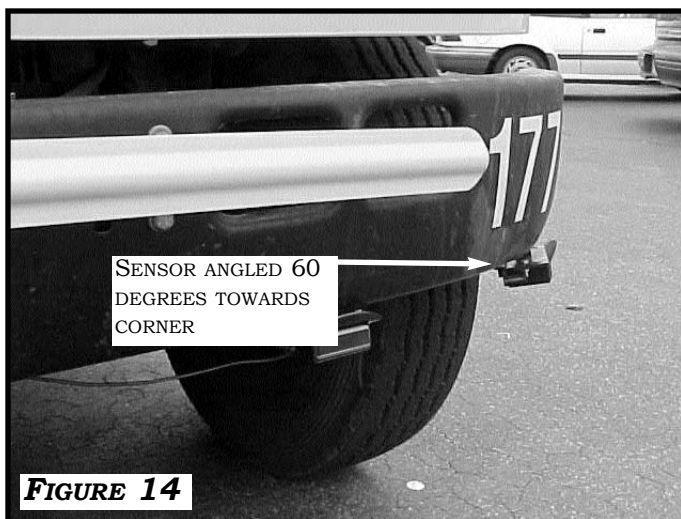

**FIGURE 14**

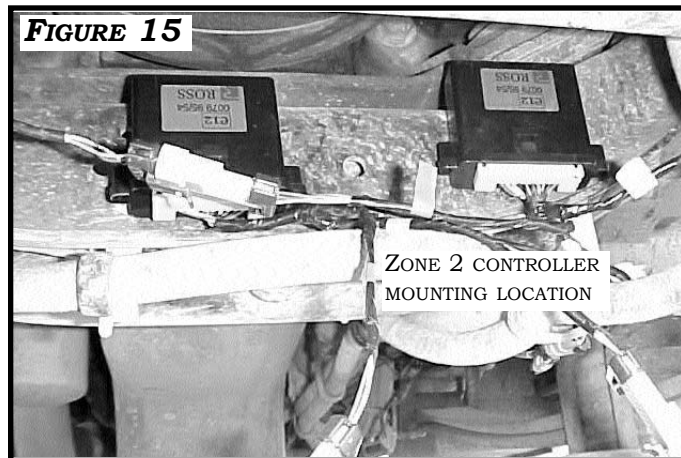
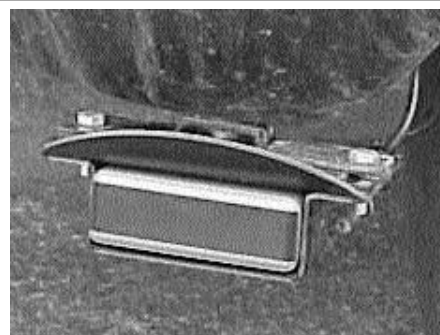
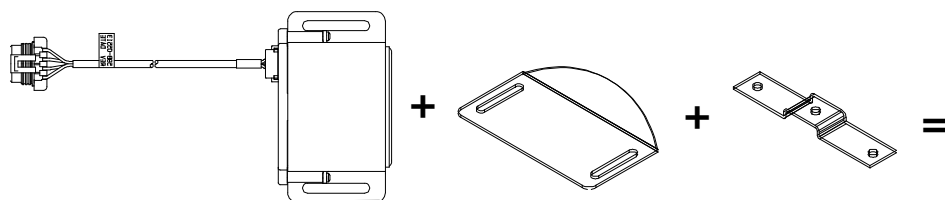

**FIGURE 15**

**NOTE:** WHILE ALL OF THE MODULES AND HARNESSSES IN THE SDS™ SYSTEM ARE DESIGNED TO WITHSTAND THE INDUSTRY STANDARDS FOR HEAT, IT IS NOT RECOMMENDED TO MOUNT CONTROLLERS NEAR THE ENGINE OR EXHAUST MANIFOLDS.

\*\*SEE PAGE 15

**FIGURE 16**



# INSTALLATION

## STEP 5: ZONES 3 AND 5 SENSORS AND CONTROLLERS MOUNTING

1. ZONE 3 IS THE AREA OF THE BUS COVERED BY THE SENSORS MOUNTED TO THE SIDEWALL IN FRONT OF THE REAR TIRES. ZONE 5 IS THE AREA COVERED BY THE TWO SENSORS MOUNTED ALONG THE SIDEWALL BEHIND THE DOOR. REFER TO **DIAGRAMS 1 AND 4** FOR SENSOR LOCATIONS. PLACE THE TOP PLATE SENSOR BRACKET ONTO THE SENSOR ASSEMBLY BY LINING UP THE TWO MOUNTING SLOTS. POSITION THE BRACKETS ON THE BOTTOM EDGE OF THE SIDEWALL AND DRILL A 1/4" HOLE FOR EACH OF THE TWO SLOTS INTO THE SIDEWALL SUPPORT BRACE. MOUNT THE SENSOR ASSEMBLIES TO THE SIDEWALL IN THE POSITIONS SHOWN IN **FIGURES 17-18**. IF THE BOTTOM LIP OF THE SIDEWALL IS ANGLED, LIKE ON MOST THOMAS BUS BODIES, THEN INSTALL ONE OF THE ANGLED SIDEWALL MOUNTING BRACKETS TO THE SIDEWALL BY DRILLING 1/4" HOLES, AND USING THE PRE-DRILLED HOLES IN THE BRACKET AS A GUIDE. MOUNT THE SIDEWALL BRACKET USING THE 20MM BOLTS. NOW ATTACH THE SENSOR ASSEMBLY WITH THE TOP PLATE BRACKET IN PLACE TO THE SIDEWALL MOUNTING BRACKET. SECURE THE ASSEMBLY OF BRACKETS USING THE HARDWARE IN THE KIT.

### FIGURE 20

2. THE TWO CONTROLLERS SHOULD MOUNT ON THE BUS FRAME IN CLOSE PROXIMITY TO THE ZONE 3 AND 5 SENSORS. MOUNT THE CONTROLLERS USING THE 35MM BOLTS SUPPLIED IN THE KIT. REFER TO **DIAGRAM 4** FOR SENSOR- CONTROLLER MATCH-UP. **FIGURE 19**
3. CONNECT THE SENSORS TO THE CONTROLLER VIA THE 8 FOOT SENSOR EXTENSION HARNESES. CONNECT THE CONTROLLER TO THE MCT HARNESS VIA THE 6 FOOT CONTROLLER EXTENSION HARNESS.\*\* REFER TO **DIAGRAM 3** FOR CONNECTION DESCRIPTION. SECURE ALL HARNESES WITH WIRE TIES.

\*\*SEE PAGE 15

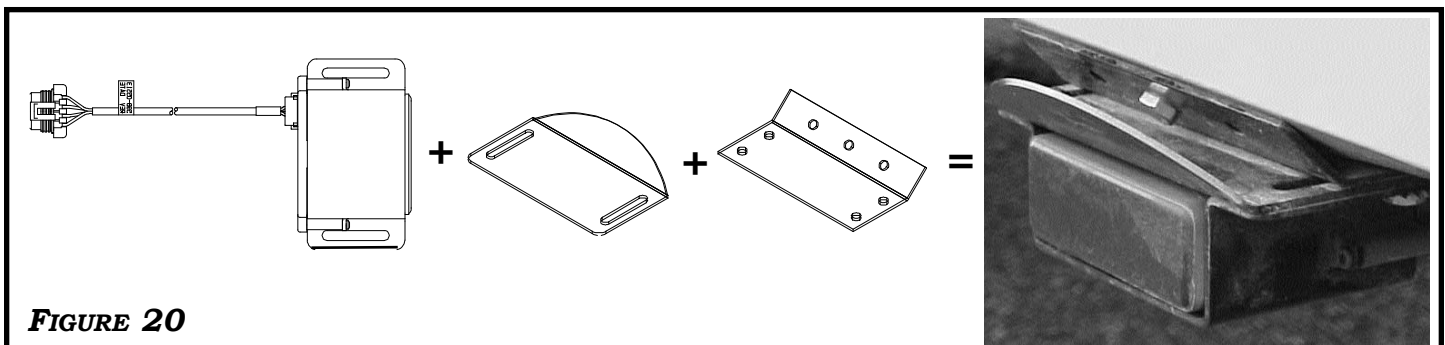
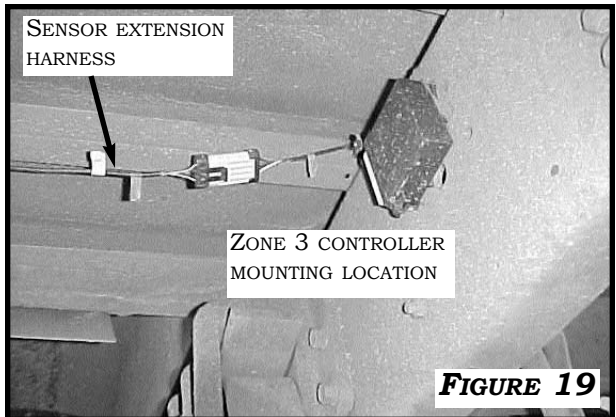
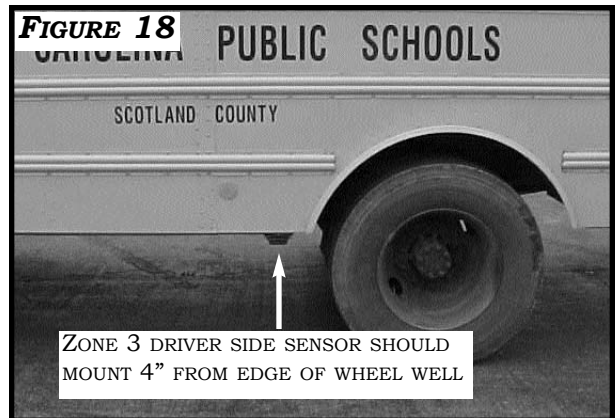
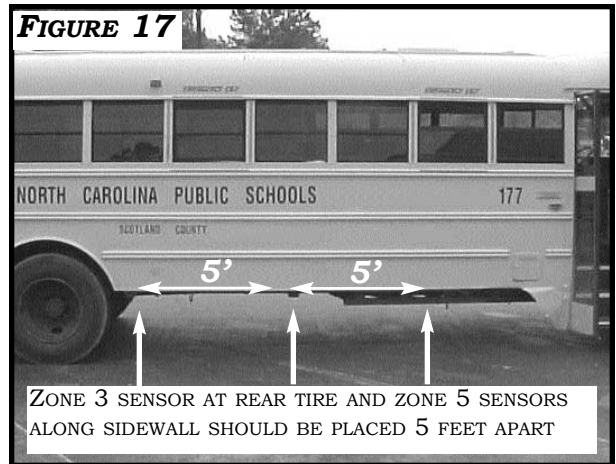

# INSTALLATION

## STEP 6: ZONE 4 SENSORS AND CONTROLLER MOUNTING

1. ZONE 4 IS THE AREA OF THE BUS COVERED BY THE TWO SENSORS MOUNTED TO THE REAR BUMPER OF THE BUS. REFER TO **DIAGRAMS 1 AND 4** FOR SENSOR LOCATIONS. THIS ZONE, ALSO REFERRED TO AS THE REARSENTRY ZONE, IS ONLY ACTIVE IN REVERSE GEAR. THE SENSORS MOUNT THE SAME WAY THEY DO ON THE FRONT BUMPER, BUT DO NOT USE THE TOP PLATE SENSOR BRACKET. THEY SHOULD BE PLACED APPROXIMATELY ONE-THIRD TO ONE-FOURTH OF THE LENGTH OF THE BUMPER FROM EACH END AS SHOWN IN **FIGURE 21**. LINE UP THE SENSOR BRACKET ASSEMBLY WITH THE BOTTOM EDGE OF THE BUMPER AND DRILL ONE 1/4" HOLE PER SLOT OF THE SENSOR BRACKET INTO THE BUMPER. THEN MOUNT THE SENSOR TO THE BUMPER USING THE 20MM BOLTS, WASHERS, AND 10MM NUTS SUPPLIED IN THE HARDWARE KIT. **FIGURE 22**. MAKE SURE THE SENSOR FACE IS FLUSH WITH THE EDGE OF THE BUMPER AS SHOWN IN **FIGURE 23**.
2. THE CONTROLLER MODULE SHOULD MOUNT IN ANY AVAILABLE AREA IN CLOSE PROXIMITY TO THE ZONE 4 SENSORS. IT CAN BE PLACED ON A FRAME CROSSMEMBER OR BUMPER SUPPORT. MOUNT THE CONTROLLER USING THE 35MM BOLTS SUPPLIED IN THE KIT. **FIGURE 15**
3. CONNECT THE SENSORS TO THE CONTROLLER VIA THE 3 FOOT SENSOR EXTENSION HARNESSES. CONNECT THE CONTROLLER TO THE MCT HARNESS VIA THE 6 FOOT CONTROLLER EXTENSION HARNESS.\*\* REFER TO **DIAGRAM 3** FOR CONNECTION DESCRIPTION. SECURE ALL HARNESSES WITH WIRE TIES.

\*\*SEE PAGE 15

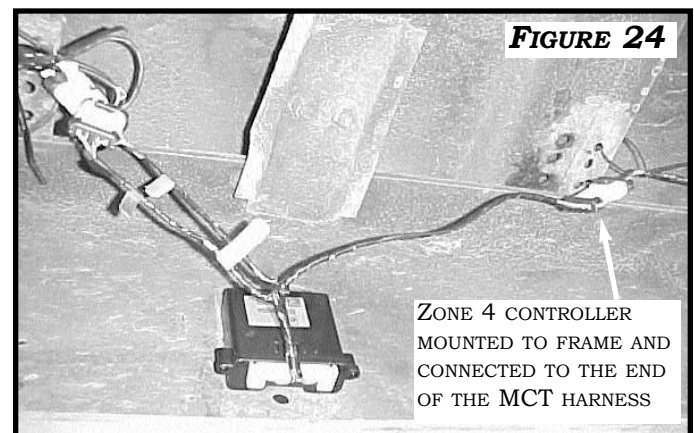
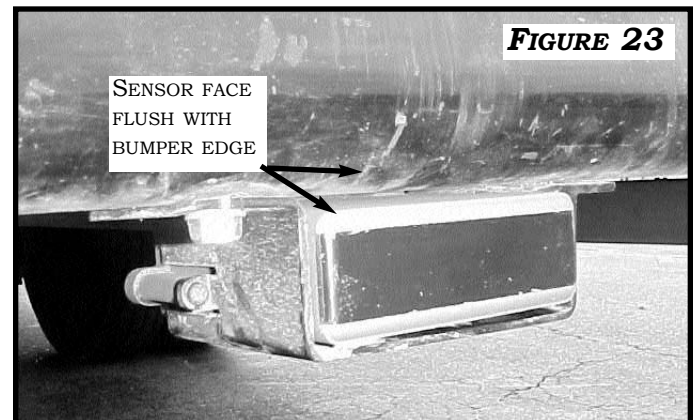
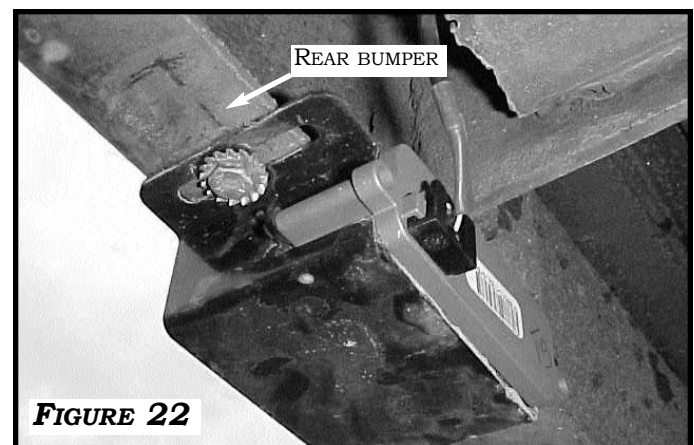
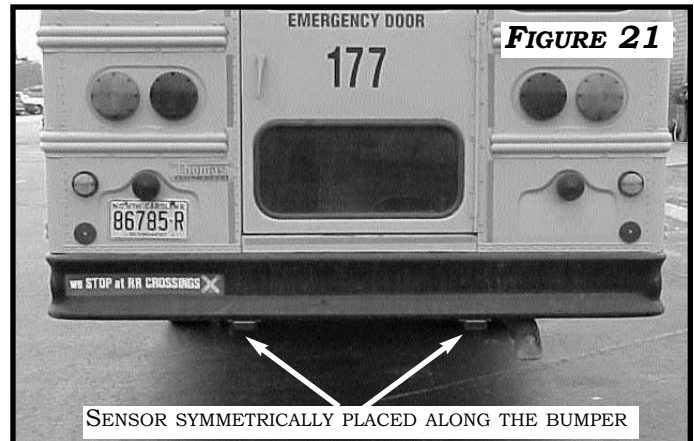

# SYSTEM CONFIGURATION PROGRAMMING

**\*\*NOTE: DO NOT CONNECT THE CONTROLLERS TO THE MCT HARNESS UNTIL PROMPTED TO DO SO IN STEP 7 BELOW. THEY NEED TO BE CONNECTED IN ORDER DURING THE CONFIGURATION SEQUENCE. UNTIL THIS STEP, LEAVE THE HARNESSES' CONNECTORS HANGING NEXT TO EACH OTHER FOR EASY ACCESS.**

## STEP 7: CONFIGURING THE SYSTEM WITH THE DRIVER DISPLAY MODULE

THE SDS™ IS SHIPPED FROM THE FACTORY AS A SYSTEM CUSTOMIZABLE FOR ONE OF TEN DIFFERENT ZONE CONFIGURATIONS DEPENDING ON THE APPLICATION. THE DRIVER DISPLAY MODULE CONTAINS ALL THE NECESSARY INFORMATION TO SET UP A SYSTEM FOR ALMOST ANY COMBINATION OF THE FIVE ZONES. THE INSTALLER CAN PROGRAM THE SYSTEM USING THE BUTTON LOCATED UNDER THE ROSTRA LOGO.  ONCE ALL THE COMPONENTS ARE INSTALLED AND THE DRIVER DISPLAY MODULE IS MOUNTED IN ITS PERMANENT POSITION, PROGRAMMING CAN BEGIN. *FIRST READ THROUGH THIS ENTIRE PROCEDURE CAREFULLY, THEN FOLLOW THE STEPS EXACTLY. MOST ACTIONS ARE TIME-SENSITIVE AND REQUIRE CLOSE ATTENTION:*

- 7A.** TURN ON THE IGNITION BUT DO NOT START THE ENGINE.
- 7B.** PRESS AND HOLD THE BUTTON FOR 3 SECONDS WITHIN THE FIRST 10 SEC. OF IGNITION ON.  
**NOTE: THE DISPLAY IS SHIPPED FROM THE FACTORY ALREADY SET IN CONFIGURATION MODE. IF THIS IS THE FIRST INSTALLATION FOR THE DISPLAY, JUMP TO STEP 7E.** IF THERE ARE ANY FAULT CODES IN MEMORY, THEY WILL BE SHOWN NOW. TO DECODE AND CLEAR THE ACTIVE AND/OR INACTIVE FAULT CODES, SEE THE SDS DIAGNOSTIC CODE MANUAL SUPPLIED IN THIS KIT. IF THERE ARE NO FAULT CODES, THEN THE GREEN LEDs SHOWING CURRENTLY CONFIGURED ZONES WILL BE LIT.
- 7C.** PRESS AND HOLD THE BUTTON FOR 3 SECONDS. THE LEDs ON THE LEFT AND THE RIGHT SIDES OF THE DISPLAY WILL ALTERNATELY FLASH FOR 2 SECONDS PER SIDE.
- 7D.** WHILE THE LEDs ON THE RIGHT SIDE OF THE BUS GRAPHIC ON THE DISPLAY ARE LIT, PRESS AND RELEASE THE BUTTON. THE LEDs ON THE RIGHT SIDE WILL BEGIN TO FLASH QUICKLY.
- 7E.** PRESS AND RELEASE THE BUTTON. THE TWO RED LEDs FOR THE FIRST CONFIGURATION SET WILL LIGHT UP. IN EVERY CASE, THE FIRST PRESS OF THE BUTTON SELECTS THE ZONE 1 CONFIGURATION SET. EACH SUBSEQUENT PRESS OF THE BUTTON WILL SELECT ANOTHER SET, AND THE CORRESPONDING RED LEDs FOR THE ADDITIONAL ZONES WILL BE LIT. CONTINUE TO PRESS AND RELEASE THE BUTTON UNTIL ONE OF THE TEN AVAILABLE CONFIGURATION SETS IS DESIRED. THE TABLE ON PAGE 16 LISTS WHICH ZONE(S) ARE ACTIVE FOR EACH CONFIGURATION SET. FOR EXAMPLE, IF THE CONFIGURATION SET ACTIVATING ZONES 1 AND 3 IS DESIRED, PRESS THE BUTTON SEVEN TIMES TO SELECT CONFIGURATION 7. FOUR RED LEDs WILL LIGHT UP; THE 2 AT THE VERY FRONT OF THE BUS, AND ONE ON EITHER SIDE OF THE BUS NEAR THE REAR TIRES. ONCE THE SYSTEM HAS CYCLED TIMES, THE CYCLE WILL REPEAT STARTING WITH THE FIRST CONFIGURATION SET (ZONE 1).

# CONFIGURATION PROGRAMMING

## STEP 7: CONFIGURING THE SYSTEM WITH THE DRIVER DISPLAY MODULE (CONTINUED)

CONFIGURATION	ACTIVE ZONE(S)	CONFIGURATION	ACTIVE ZONE(S)
1	1 ONLY	6	1, 3
2	1, 2	7	1, 4
3	1, 2, 3	8	1, 2, 4
4	1, 2, 3, 5	9	1, 2, 3, 4
5	1, 2, 3, 4, 5	10	1, 3, 4

**7E. (CONT.)** ONCE A CONFIGURATION SET IS SELECTED AND THE BUTTON HAS NOT BEEN PRESSED WITHIN 3 SECONDS, THE RED LEDs TURN OFF AND THE GREEN LEDs FOR THE AFFECTED ZONE(S) WILL COME ON FOR 2 SECONDS. THEN BOTH LEDs FOR THE FIRST ZONE TO BE CONFIGURED WILL FLASH. PLUG THE CONTROLLER THAT CORRESPONDS TO THAT ZONE INTO THE MCT HARNESS. SYSTEM PARAMETERS WILL BE DOWNLOADED FROM THE DISPLAY TO THE CONTROLLER. ONCE THIS IS COMPLETED, THE ZONE'S LEDs WILL STOP BLINKING, AND THE GREEN LED LIGHT UP SOLID. THE DISPLAY WILL THEN AUTOMATICALLY MOVE ON TO THE NEXT ZONE. WHEN THE RED AND GREEN LEDs FOR A PARTICULAR ZONE BEGIN TO FLASH, THE DISPLAY IS READY FOR THAT CORRESPONDING CONTROLLER TO BE CONNECTED TO THE MCT HARNESS. CONTINUE THIS STEP UNTIL ALL CHOSEN ZONES' GREEN LEDs LIGHT UP SOLID.

**7F.** EXIT THE CONFIGURATION MODE BY TURNING OFF THE IGNITION. IF THE CONFIGURATION MODE WAS COMPLETED, THEN THE NEXT TIME THE IGNITION IS TURNED ON, THE SYSTEM WILL BE IN NORMAL MODE AND READY FOR OPERATION. IF THE CONFIGURATION SEQUENCE WAS NOT COMPLETED, THE SYSTEM WILL COME BACK UP IN CONFIGURATION MODE AGAIN. **IF DURING THE CONFIGURATION SEQUENCE A NEW CONFIGURATION SET IS DESIRED, PRESS AND HOLD THE BUTTON FOR 3 SECONDS TO ERASE THE CURRENT SELECTION (ALL RED LEDs BLINK QUICKLY), TURN OFF THE IGNITION, AND GO BACK TO STEP 7A.**



# SYSTEM TESTING

## STEP 8: TEST THE SYSTEM FOR PROPER OPERATION

1. ACTIVATE THE SDS™ BY TURNING ON THE STATE LIGHTS. VERIFY THAT THE GREEN LEDs FOR ALL ACTIVE COVERAGE ZONES COME ON IMMEDIATELY. VERIFY THAT THE FRONT ZONE LEDs COME ON AFTER A 4 SECOND DELAY TO ALLOW THE CROSSING GATE TO SWING OUT.
2. WALK TOWARDS THE BUS INTO EACH OF THE DESIGNATED DANGER ZONES AS SHOWN BY THE ARROWS IN **DIAGRAM 5**. THE SYSTEM SHOULD DETECT YOUR PRESENCE WITHIN 5 FEET OF ANY GIVEN SENSOR. VERIFY THAT THE DRIVER DISPLAY SOUNDS ONE AUDIBLE ALERT PER INTRUSION, AND THAT THE CORRESPONDING RED LED ON THE DISPLAY IS FLASHING. VERIFY THAT WHEN YOU EXIT THE DANGER ZONE AND IT HAS NOT RECEIVED ANY OTHER INTRUSIONS WITHIN 5 SECONDS, THE RED LED GOES OFF AND THE SOLID GREEN LED COMES ON TO INDICATE “ALL CLEAR”.
3. DEACTIVATE THE SDS™. VERIFY THAT THE FRONT LEDs TURN OFF IMMEDIATELY AND THAT THE REMAINING LEDs FOR THE OTHER ACTIVATED ZONES TURN OFF AFTER A 4 SECOND DELAY.
4. ACTIVATE THE ROSS™ ZONE 4 BY PUTTING THE BUS IN REVERSE. VERIFY THAT GREEN LED COMES ON UPON SYSTEM ACTIVATION, AND THE AMBER AND RED LEDs LIGHT UP AS AN ASSISTANT APPROACHES THE REAR BUMPER OF THE BUS.

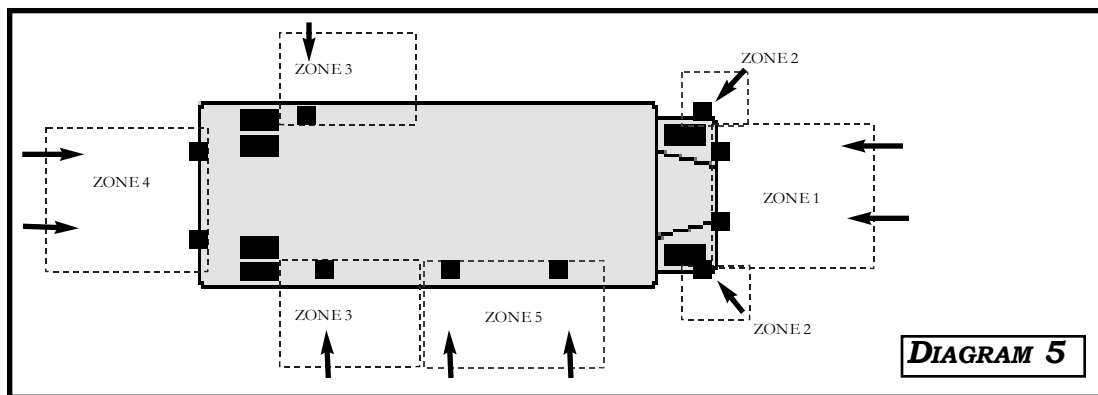

# ***NOTES***

# ***NOTES***

**SDS** by ROSTRA  
PRECISION  
CONTROLS