

GENERAL APPLICABILITY

CHEVROLET CRUZE - AT & MT

KIT CONTENTS/SERVICE PARTS

| ITEM | QTY | DESCRIPTION | PART# |
|------|-----|-------------------------|------------------------------|
| 1 | 1 | CRUISE CONTROL MODULE | 250-2825-A/T 250-2835-M/T |
| 2 | 1 | SWITCH HARNESS | 250-2760 |
| 3 | 1 | PEDAL INTERFACE HARNESS | 250-2823 |
| 4 | 1 | HARDWARE KIT | 250-2767 |
| 5 | 1 | CONTROL SWITCH | 250-3742 |
| 6 | 1 | DIAGNOSTICS HARNESS | 250-2785 |

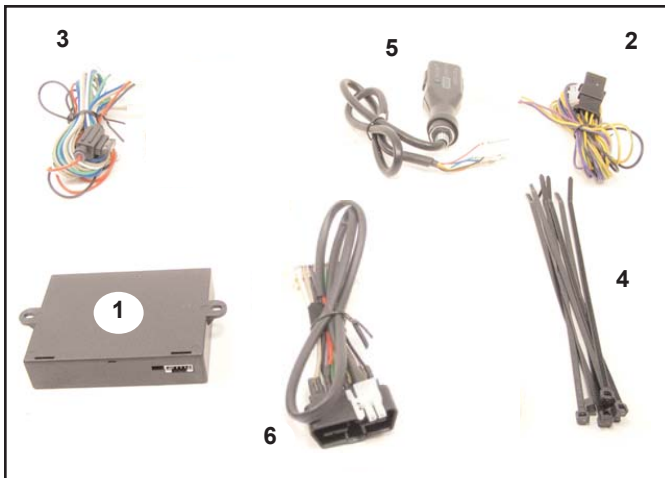

HARDWARE BAG CONTENTS

| ITEM | QTY | DESCRIPTION |
|------|-----|---------------|
| 1 | 8 | WIRE ZIP TIES |
| 2 | | |
| 3 | | |







RECOMMENDED TOOLS

| PERSONAL & VEHICLE PROTECTION | |
|-------------------------------|----------------------------|
| SAFETY GLASSES | |
| | |
| SPECIAL TOOLS | |
| VOLT-OHM METER | |
| INSTALLATION TOOLS | |
| TRIM REMOVAL TOOL | PHILLIPS SCREWDRIVER |
| 10-MM WRENCH | |
| DRILL BITS | 9.5MM OR 3/8" (FOR SWITCH) |
| 14MM WRENCH | |
| SOLDERING TOOL | |
| SPECIAL CHEMICALS | |
| | |
| | |

CONFLICTS

NOTE:

LEGEND

-  **STOP:** DAMAGE TO VEHICLE MAY OCCUR. DO NOT PROCEED UNTIL PROCESS COMPLIANCE HAS BEEN MET.
-  **OPERATOR SAFETY:** USE CAUTION TO AVOID RISK OF INJURY.
-  **CRITICAL PROCESS:** PROCEED WITH CAUTION TO ENSURE A QUALITY INSTALLATION. THESE POINTS WILL BE AUDITED ON A COMPLETED VEHICLE INSTALLATION.
-  **GENERAL PROCESS:** THIS HIGHLIGHTS SPECIFIC PROCESSES TO ENSURE A QUALITY INSTALLATION. THESE POINTS WILL BE AUDITED DURING THE ACCESSORY INSTALLATION.
-  **TOOLS & EQUIPMENT:** THIS CALLS OUT THE SPECIFIC TOOLS AND EQUIPMENT REQUIRED FOR THE PROCESS.
-  **REVISION MARK:** THIS MARK HIGHLIGHTS A CHANGE IN INSTALLATION WITH RESPECT TO PREVIOUS ISSUE.



WARNING: DO NOT USE HAND-HELD 2-WAY TRANSCEIVERS INSIDE YOUR VEHICLE WHILE DRIVING.

WHEN TRANSMITTING FROM INSIDE THE CAR, 2-WAY RADIOS THAT OPERATE IN THE 25MHZ-700MHZ FREQUENCY RANGE WITH MORE THAN 2.0 WATTS OF POWER CAN PRODUCE ELECTROMAGNETIC INTERFERENCE THAT COULD INTERFERE WITH THE OPERATION OF CRUISE AND THROTTLE CONTROLS RESULTING IN VEHICLE "LIMP MODE".

USE OF CELLULAR PHONES WILL NOT INTERFERE WITH THESE CONTROLS.



DUE TO SENSITIVE NATURE OF SIGNALS USED FOR THIS PRODUCT, ALL NON-PLUG AND PLAY CONNECTIONS MUST BE SOLDERED. FAILURE TO COMPLY WITH THIS REQUIREMENT WILL VOID WARRANTY.

**BEFORE INSTALLATION**

To make the installation easier, the complete installation instructions should be read through before installation is started.

This installation instructions contains information how to install the Electronic Cruise Control which is not a Do-It-Yourself job.

Modern cars are equipped with electronics, which can be costly damaged by inappropriate treatment.

Rostra Precision Controls can not be held responsible for any error caused by wrong installation

**SOME GOOD ADVICE**

Always disconnect the negative cable from battery before installation.

Always use the enclosed installation instruction for installing the Electronic Cruise Control.

Check the part number of the cruise module label is the same compared to the part number of the installation instructions.

Be aware of radio codes that might have to be typed in.

Find a location to install the cruise module and control switch

If any wires are left, then cut off and insulate.

Only use a multimeter to measure voltage.

Always drive the car for a complete test before assembling the car.

All wire leads must be soldered.

INSTALLATION

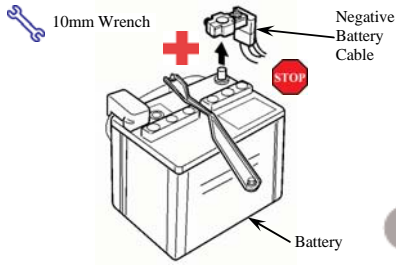

White
Red
Yellow
Green
Red

Black
Red

Connect data harness cap to OBD2 connector
Optional *Cut the Rostra connector off and solder wires: Red Wire to Pin 6, Black Wire to Pin 14

Ignition Red Wire

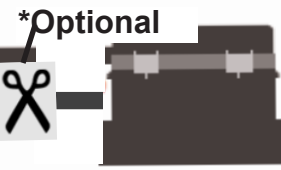

To OBD2 Connector

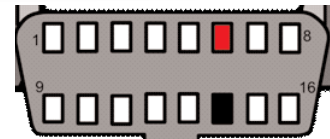

SOLDER RED IGNITION WIRE FROM CRUISE HARNESS TO VIOLET/BLACK WIRE IN IGNITION SWITCH HARNESS LOCATED BELOW STEERING COLUMN

Connect to the accelerator pedal

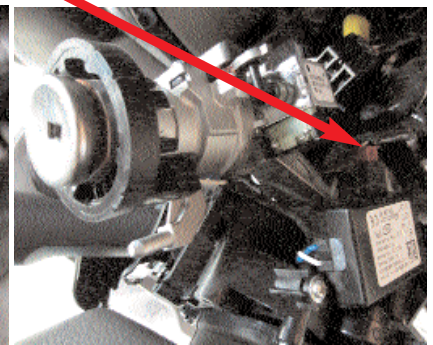
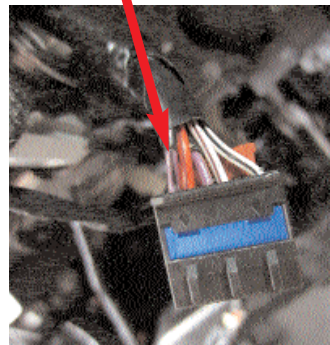
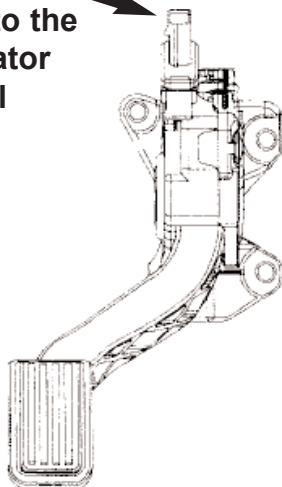

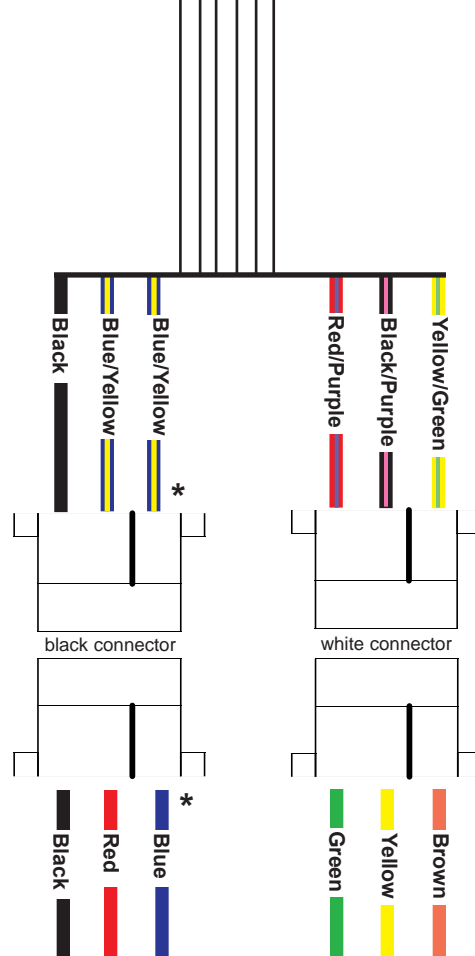

| Switch Harness | Rostra Switch |
|----------------|---------------|
| BLACK | BLACK |
| BLUE/YELLOW | RED |
| BLUE/YELLOW* | BLUE* |
| RED/PURPLE | GREEN |
| BLACK/PURPLE | YELLOW |
| YELLOW/GREEN | BROWN |

* Both Blue/Yellow wires are spliced together. Just connect one BLU/YEL wire to the BLUE, and the other to the RED. The order does not matter.

 Do not drill hole for control switch before testing the cruise system

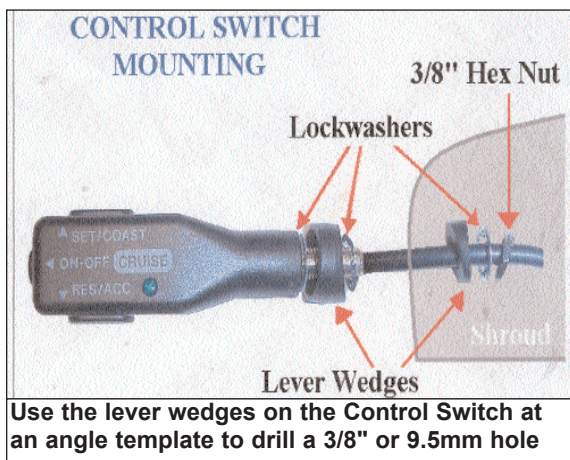

Use the lever wedges on the Control Switch at an angle template to drill a 3/8" or 9.5mm hole

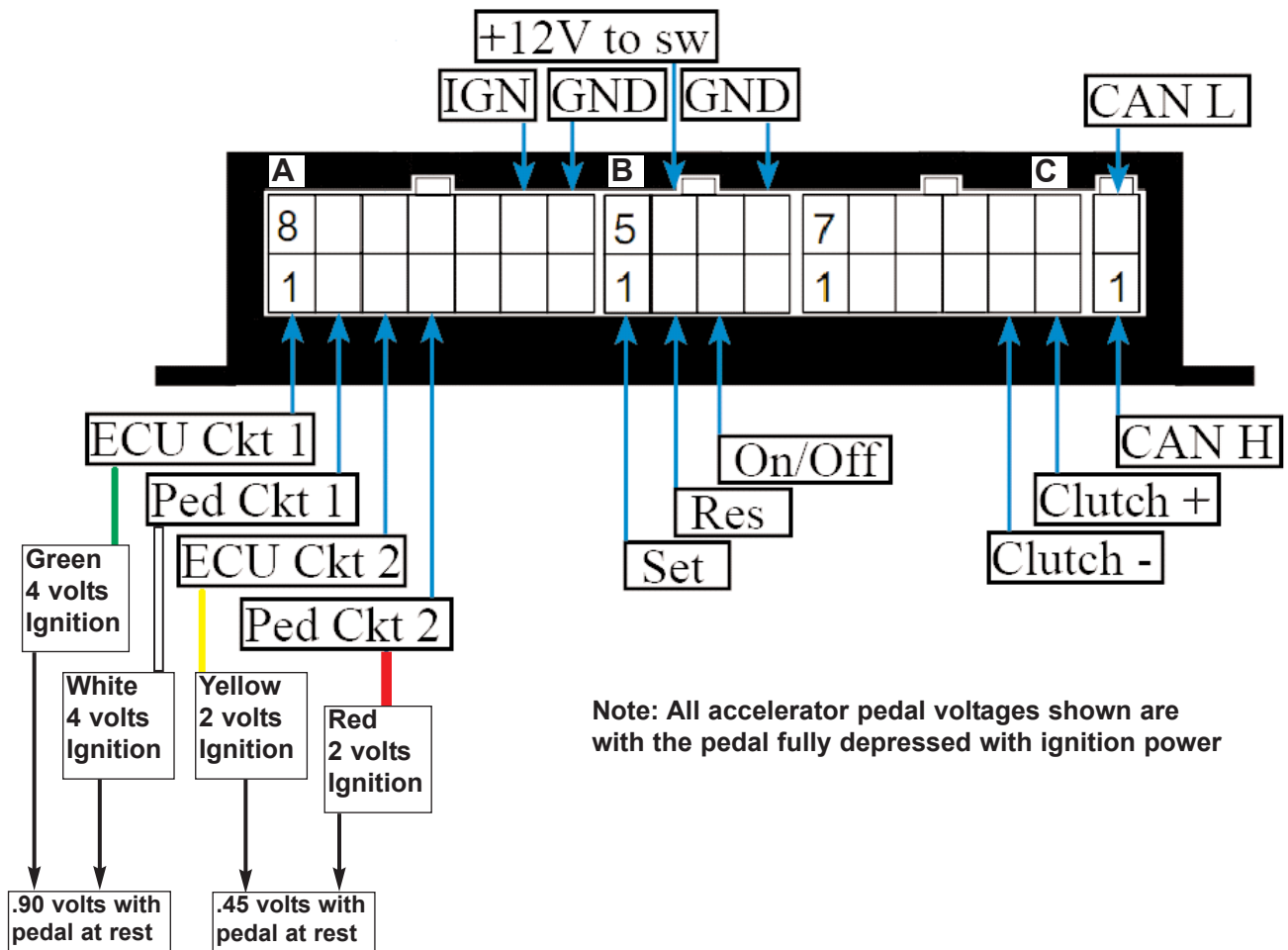

| PIN | COLOR | DESIRED RESULTS | FAULT CONDITION |
|----------|-----------------------|---|--|
| 13A | RED | +12V WHEN SWITCHED ON AND +0V WHEN SWITCHED OFF. IGNITION MUST BE GREATER THAN +10V WHILE CRANKING VEHICLE. | NO POWER, VOLTAGE DROP, OR INTERMITTENT CONNECTION WILL CAUSE LOSS OF PEDAL OR "LIMP MODE" CONDITION. |
| 14A | BLACK | LOWEST RESISTANCE TO GROUND AND CLOSEST TO ZERO (0) OHMS AS POSSIBLE. USE A VEHICLE GROUND POINT WHERE OTHER GROUND WIRES ARE CONNECTED TO. | A BAD GROUND CONNECTION WILL CAUSE THE FOLLOWING CONDITIONS: CRUISE WILL NOT FUNCTION, LOSS OF PEDAL OR "LIMP MODE" CONDITION. |
| 1B | GREEN | SET/COAST: 12V PRESS AND HOLD SET | CRUISE WILL NOT SET IF THIS CONNECTION IS NOT INSTALLED CORRECTLY. |
| 2B | YELLOW | RESUME/ACCEL: 12V PRESS AND HOLD RESUME | CRUISE WILL NOT RESUME OR ACCEL IF THIS CONNECTION IS NOT INSTALLED CORRECTLY. |
| 3B | BROWN | ON/OFF: 12V PRESS ON | CRUISE WILL NOT SET IF THIS CONNECTION IS NOT INSTALLED CORRECTLY. |
| 6B 8B | RED AND BLUE BLACK | 12V (0) OHMS RESISTANCE TO GROUND | CRUISE LIGHT WILL NOT COME ON IF THESE CONNECTIONS ARE NOT INSTALLED CORRECTLY. |

